

## **Automaten Hoffmann Billardtisch „Club Pro“**

Automaten Hoffmann Billard Table „Club Pro“

**Aufbauanleitung 9ft Tische**  
Assembly manual: 9ft tables

**Billard**

**D**

**Herzlichen Glückwunsch! Wir hoffen Sie werden viel Spaß mit Ihrem neuen Kickertisch haben!**



**Please keep your instructions!**

- Sie brauchen Ihre Seriennummer wenn Sie uns kontaktieren.
- Bitte lesen Sie sich vor der Montage die Anleitung sorgfältig durch und machen sich mit den Bauteilen vertraut
- Bitte überprüfen Sie vor Beginn der Montage ob alle Teile vollständig sind.



**Kontakt Information:**

Automaten Hoffmann  
c/o Sport-Thieme GmbH  
Helmstedter Straße 40  
38368 Grasleben  
Telefon: 05357 181-45  
www.automaten-hoffmann.de



**Warnung!**

- Bitte bewahren Sie Schmiermittel und Bälle außerhalb der Reichweite von Kindern auf
- Sprühen Sie das Schmiermittel nicht auf Personen oder Tiere Lassen Sie Ihre Kinder nicht unbeaufsichtigt mit dem Kickertisch spielen
- Bitte seien Sie im Umgang mit den Kickerstangen vorsichtig um Verletzungen zu vermeiden
- Bitte lesen Sie die Aufbauanleitung sorgfältig um Verletzungen oder Beschädigungen zu vermeiden



**Folgende Werkzeuge werden zur Montage benötigt:**

- Schlitzschraubenzieher, Kreuzschlitzschraubenzieher, Akkuschrauber, nicht enthalten
- Werkzeug für Spannstift (# 21), Innensechskant-Schlüssel (#14) (enthalten)

**GB**

**Congratulations! We hope you will have many hours to use your new soccer table and enjoy the pleasure it brings to you !**



**Bitte halten Sie sich an die Aufbauanleitung**

- Your Model number is needed when you contact us.
- Please read through this instruction book to familiarize yourself with all the parts and assembly steps.
- Please find the attached tables for all the parts' name, specification and quantity.



**Kontakt Information:**

Automaten Hoffmann GmbH  
c/o Sport-Thieme  
Helmstedter Straße 40  
38368 Grasleben, Germany  
Phone: +49 5357 181-45  
www.automaten-hoffmann.de



**Warning!**









- Please keep the balls, lubricant and other parts out of children's reach.
- Don't spray the lubricant to any person or animal.
- This is not a child's toy. Adult supervision is required for children playing this game.
- please take care to avoid injuring any thing or person when you push and pull the player rods .
- Please read instructions carefully. Proper use of this set can avoid damage or injury .





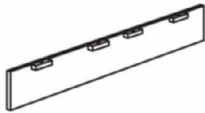

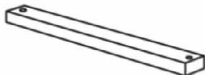

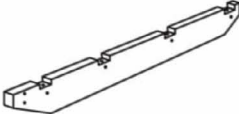
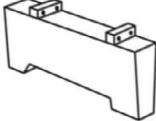



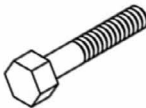

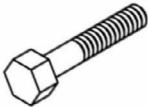



**Tools required for assembly:**

- Phillips and Slotted Head Screwdrivers , Power Driver or Hammer(not included)
- Roll Pin Punch (#21), Allen Key (#14) (included)

## Stückliste | Parts list

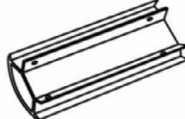
<p>A</p>  <p><b>2x Bandenrahmen lange Seite (A)</b> Long top rail (A)</p>	<p>B</p>  <p><b>2x Bandenrahmen lange Seite (B)</b> Long top rail (B)</p>	<p>C</p>  <p><b>1x Bandenrahmen kurze Seite (A)</b> End top rail (A)</p>	<p>D</p>  <p><b>1x Bandenrahmen kurze Seite (B)</b> End top rail (B)</p>
<p>E</p>  <p><b>2x Lange Seitenverblendung (A)</b> Long apron</p>	<p>F</p>  <p><b>1x Kurze Seitenverblendung (A)</b> End apron (A)</p>	<p>G</p>  <p><b>1x Kurze Seitenverblendung (B)</b> End apron (B)</p>	<p>H</p>  <p><b>2x Querstrebe</b> Cross Member</p>
<p>I</p>  <p><b>2x Mittlere Querstrebe</b> Mid Cross Member</p>	<p>J</p>  <p><b>2x Langes Rahmenteil</b> Long Frame</p>	<p>K</p>  <p><b>2x Bein</b> Leg</p>	

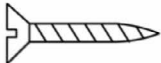
## Stückliste | Parts list

<p>#1</p>  <p><b>4x Höhenverstellbarer Fuß</b> Leg leveller</p>	<p>#2</p>  <p><b>8x Schraube</b> M10X4-1/2" Bolt</p>	<p>#3</p>  <p><b>24x Unterlegscheibe</b> 3/8X25mm Washer</p>	<p>#4</p>  <p><b>8x Mutter</b> M10mm Nut</p>
<p>#5</p>  <p><b>8x Schraube</b> 3/8"X4" Bolt</p>	<p>#6</p>  <p><b>8x Bolzen</b> 3/8" Nut</p>	<p>#7</p>  <p><b>30x Schraube</b> 5/16"X1-3/4" Bolt</p>	<p>#8</p>  <p><b>12x Unterlegscheibe</b> 5/16"X23mm Washer</p>
<p>#9</p>  <p><b>18x Unterlegscheibe</b> 5/16"X35mm Washer</p>	<p>#10</p>  <p><b>8x Schraube</b> 1/4"X1" Bolt</p>	<p>#11</p>  <p><b>8x Unterlegscheibe</b> 1/4"X32mm Washer</p>	<p>#12</p>  <p><b>4x Eckverblendung</b> Top Corner</p>
<p>#13</p>  <p><b>18x Nagel</b> Nail</p>	<p>#14</p>  <p><b>6x Ballfangtasche</b> Plastic Pocket</p>	<p>#15</p>  <p><b>4x Verblendung Ecke</b> Apron Corner</p>	<p>#16</p>  <p><b>16x Schraube</b> T4X12mm Screw</p>
<p>#17</p>  <p><b>2x Schraube</b> F4X1" Screw</p>	<p>#18</p>  <p><b>2x Verblendung Ecke</b> Rail Cover</p>	<p>#19</p>  <p><b>1x Sechskantschlüssel</b> Wrench</p>	

Schritt/Step 1

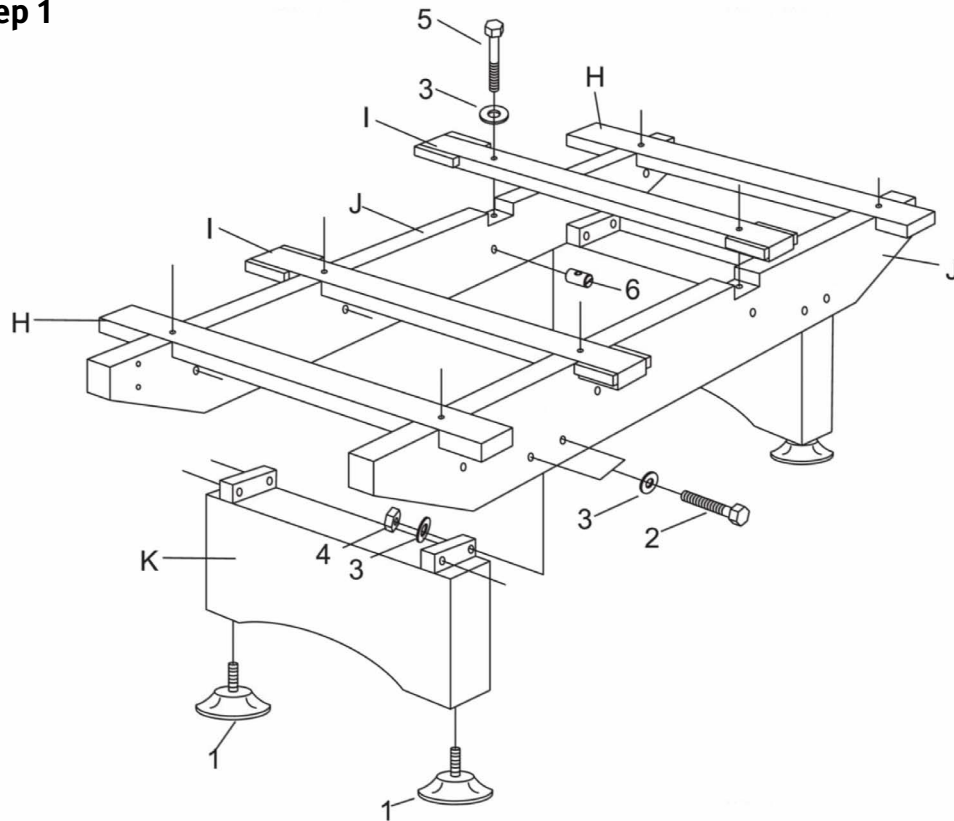

Schritt/Step 2

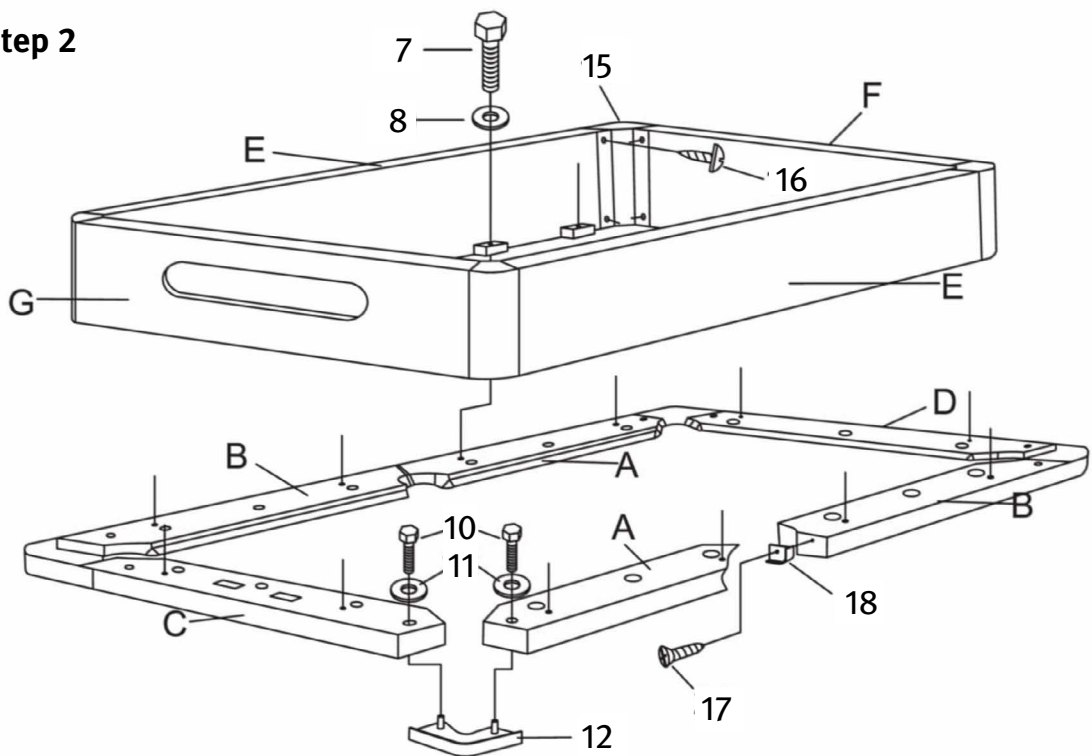

**Schritt/Step 3**

