

GYMNOVACS 30056 - 45 RUE G. DE FLOTTE
13375 MARSEILLE CEDEX 12 (FRANCE)
TEL : 33.(0)4.91.87.51.20 FAX : 33.(0)4.91.93.86.89
WWW.GYMNOVA.COM**ASSEMBLY INSTRUCTIONS**

NM254F-GB

11/01/21

**14x14M & 13x13M OVERLAY CARPETS
AND ARTISTIC GYMNASTICS EXERCISE FLOORS****6380H**
6570J-6775D-6775D/DE
6390I
6565K-6777D-6777D/DE**6570J &
6775D - 6775D/DE****KEEP THIS
DOCUMENT****Warning:**

This equipment should be installed by a qualified individual. This equipment should only be used by one person at a time, under the supervision of a qualified individual.
Using this equipment for purposes other than those originally intended is prohibited.

Compliance:

14 x 14 m Exercise floors references **6570J, 6775D et 6775D/DE** are FIG approved.

Recommendations:

- Keep these instructions for subsequent reference (inspection, maintenance, etc.).
- Periodically carry out predictive maintenance.
- Depending on how much it is used have the equipment serviced yearly or every few years.

Pack list:

PACK REF.	6380/141 Carpet left side width No. 1 14 x 4m	6380/142 Carpet central width No. 2 14 x 3m	6380/143 Carpet central width No. 3 14 x 3m	6380/144 Carpet right side width No. 4 14 x 4m	6380/108 Set of 3 hook-and- loop joining strips 14m	6532B Carpet Anti-Rotation Kit	No. of Packages
6380H Overlay carpet 14 x 14m	1	1	1	1	1	1	6
VOLUME (M³)	0,62	0,48	0,48	0,62	0,02	0,01	X
WEIGHT (KG)	99	75	75	99	2	1,55	
DIM. (MM)	4300x380x380	3350x380x380	3350x380x380	4300x380x380	370x270x200	300x200x170	

PACK REF.	6390/141 Carpet left side width No. 1 13.05 x 3.52m	6390/142 Carpet central width No. 2 13.05 x 3m	6390/143 Carpet central width No. 3 13.05 x 3m	6390/144 Carpet right side width No. 4 13.05 x 3.52m	6380/108 Set of 3 hook-and- loop joining strips 14m	6532B Carpet Anti-Rotation Kit	No. of Packages
6390I Overlay carpet 13 x 13m	1	1	1	1	1	1	6
VOLUME (M³)	0,55	0,48	0,48	0,55	0,02	0,01	X
WEIGHT (KG)	82	72	72	82	2	1,55	
DIM. (MM)	3800x380x380	3300x380x380	3300x380x380	3800x380x380	370x270x200	300x200x170	

Constantly aiming to improve our products, we reserve the right to make changes to the equipment and dimensions without further discussion.

I. Assembling the floor and the Anti-Rotation Kit:

Refer to assembly instructions NM06 + NM206 for Refs: 6580B & 6595B, NM273 + NM277 for Refs: 6785A & 6787A or NM274 + NM277 for Refs: 6781A & 6783A.

II. Assembling the impact-absorbing foam area and the finishing bibs of springs floors:

Refer to assembly instructions NM253 for Refs: 6542A & 6572A, or NM299 for Refs: 6788B & 6784B.

III. Assembling the overlay carpet: minimum.

Note: Keep the 4 cardboard core tubes flat for any future storage or moving of the carpet (without a reel trolley).

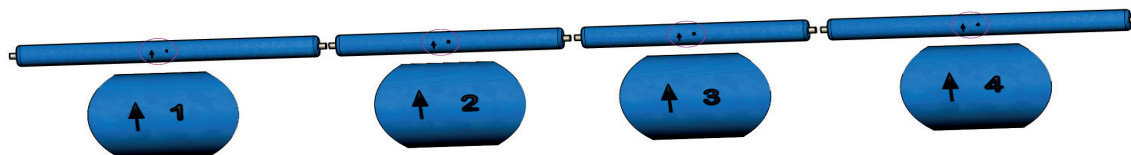

Important: In order to achieve an identical colour shade between the 4 widths (the same pile direction), simply place the 4 rolls side by side observing the order of the numbers and the direction of the arrows (marked on the packaging), as shown in the diagram above.

1/ UNROLL THE 4 WIDTHS OF CARPET RIGHT SIDE UP OVER THE FOAM: IN THE DIRECTION OF THE BLACK STRIP ON THE FOAM TRACKS (SEE FIG. 1, 2 & 3 OR 4, 5 & 6), PLACING THE 2 WIDER ONES TOWARDS THE OUTSIDE. START BY PLACING ONE OF THE 2 LARGE ROLLS (1, 1' OR 4, 4') ON ONE SIDE OF THE FOAM (LARGE RED EDGE TOWARDS THE OUTSIDE):

- 14 x 14 m Exercise floors (Ref.: 6570J, 6775D & 6775D/DE): the 4 m wide side widths (1) and (4) (see Fig. 1 to 3).
- 13 x 13 m Exercise floors (Ref.: 6565K, 6777D & 6777D/DE): the 3.52 m wide side widths (1') and (4') (see Fig. 4 to 6).

2/ REPEAT THIS STEP FOR THE SECOND LARGE ROLL, THEN UNROLL THE CENTRAL WIDTHS (2) AND (3) OR (2') AND (3') IN THE MIDDLE BETWEEN THE OTHER TWO.

3/ POSITION THE FIRST SIDE WIDTH RELATIVE TO THE FOAM AREA, ALIGNING IT WITH THE INITIAL MARKING (14 x 14 m OR 13 x 13 m):

- 14 x 14 m Exercise floor with foam blocks (Ref.: 6570J): the complete carpet overlaps by 25 cm all around the foam (see Fig. 1 & 2).
- 13 x 13 m Exercise floor with foam blocks (Ref.: 6565K): the complete carpet overlaps by 20 cm all around the foam (see Fig. 4 & 5).
- 14 x 14m & 13x13m Sprung Exercise floors (Ref.: 6775D, 6777D, 6775D/DE & 6777D/DE) : the complete carpet does not overlap the foam (see Fig. 1 & 3 for 14 x 14 m exercise floor, Fig 4 & 6 for 13 x 13 m exercise floor).

4/ ADJUST THE 4 WIDTHS SIDE BY SIDE TO FIT PERFECTLY TOGETHER. IN ORDER TO MOVE A WIDTH, ALL THAT'S REQUIRED IS TO HAVE ONE PERSON AT EACH END OF THE WIDTH AND TO LIFT IT ALTERNATELY IN ORDER TO FORCE AIR IN WAVES UNDER THE WIDTH. READJUST ITS POSITION BY PULLING IN THE DESIRED DIRECTION.

Direction of the foam tracks (in green) / Direction of carpet widths (in red)

Figure 1 - 14 x 14m Complete carpet (Ref.: 6380H)

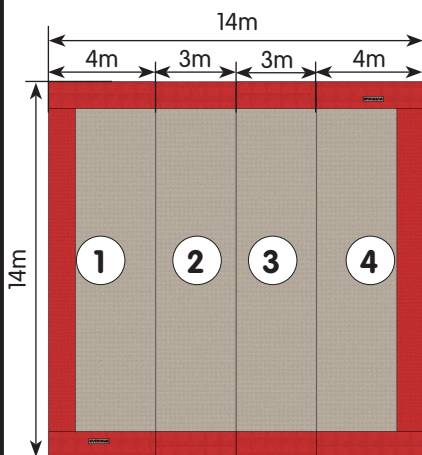

Figure 2 - 13,50 x 13,50m th. 4cm Complete foam "concertina" tracks Ex. Floor with foam blocks (Ref.: 6542A)

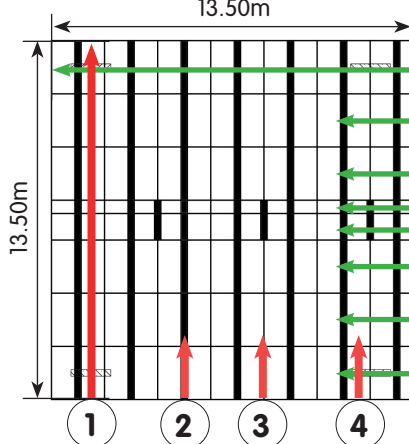

Figure 3 - 14 x 14m th. 5.6cm Complete foam "concertina" tracks Sprung Ex. Floor (Ref.: 6788B)

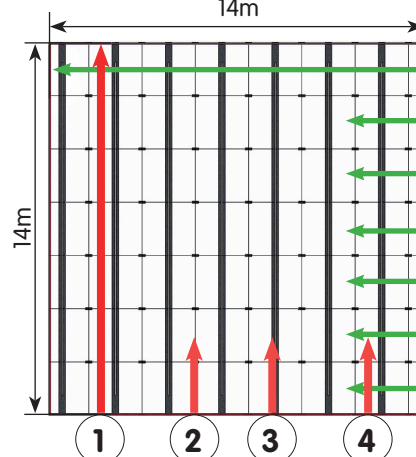

Figure 4 - 13.05 x 13.05m Complete carpet (Ref.: 6390I)

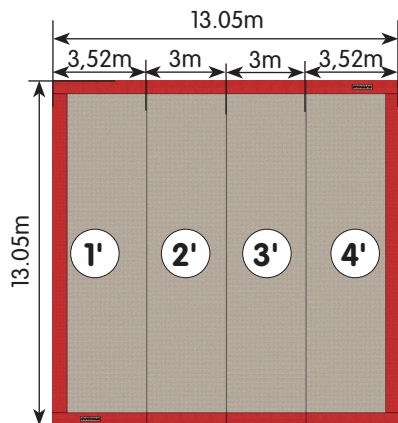

Figure 5 - 12,60 x 12,60m th. 4cm Complete foam "concertina" tracks Ex. Floor with foam blocks (Ref.: 6572A)

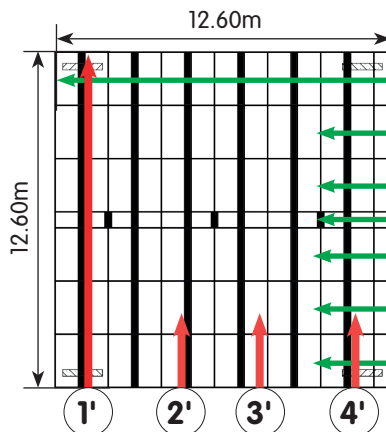
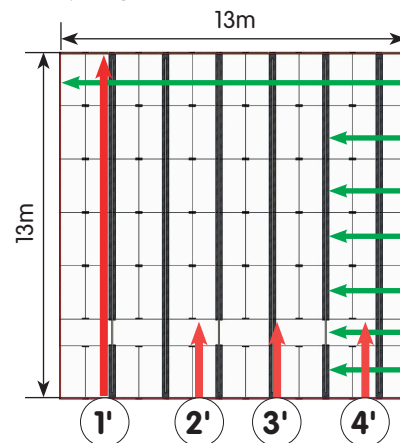

Figure 6 - 13 x 13m th. 5.6cm Complete foam "concertina" tracks Sprung Ex. Floor (Ref.: 6784B)



5/ ⚠ WARNING: TO PREVENT CREASES FORMING, LEAVE TO REST FOR AT LEAST 24 H AT USAGE TEMPERATURE (IF CREASES NEVERTHELESS APPEAR, REFER TO § V). ASSEMBLE THE 4 WIDTHS TOGETHER (SAME METHOD FOR BOTH CARPETS):

Figures 7 - 8 - 9 - Installation of a hook-and-loop joining strip on a carpet width

- Lift each end of a side width (1) finishing with the middle to expose the joining area.
- Unroll a hook-and-loop joining strip (5) (beige & red), without tension, overlapping by 5 cm over the edge of the side width (1).

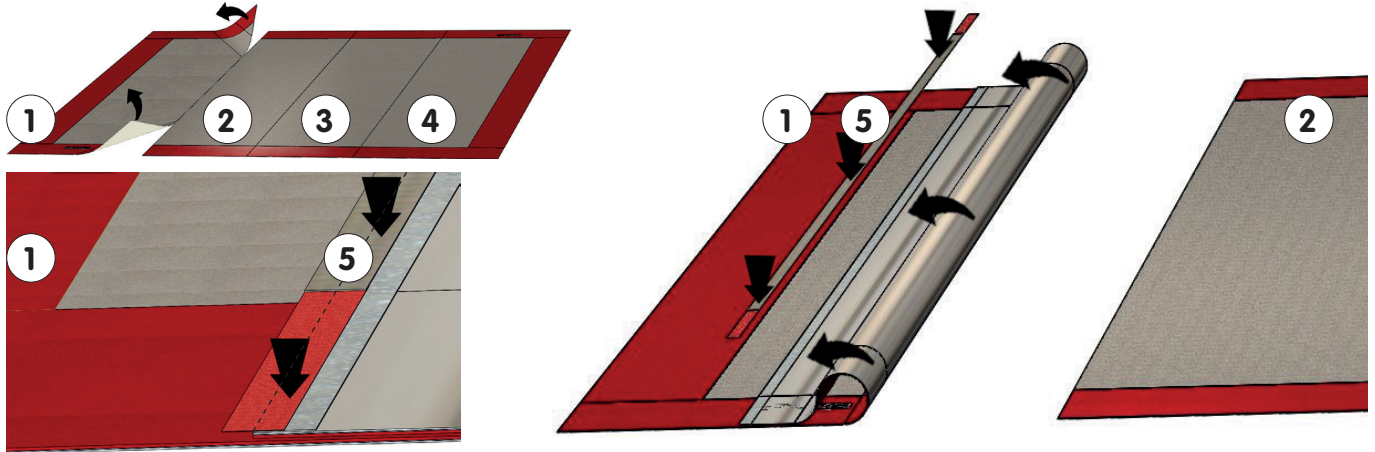

Figures 10 - 11 - 12 - 13 & detail - Finishing the connection of 2 carpet widths

- Fold the side strip (1) with the connecting strip (5) from the middle to the ends.
- Remove the edge of the central width (2) taken below the joining strip (5), lifting the ends until the middle is released.
- Gently rest the middle of the central width (2) identical to the side width, ending with the ends.
- Renew the operation for the remaining widths (3) et (4).
- Cross-check joining strips (5) if necessary (13 x 13m Exercise floors - Refs : 6565K, 6777D & 6777D/DE).

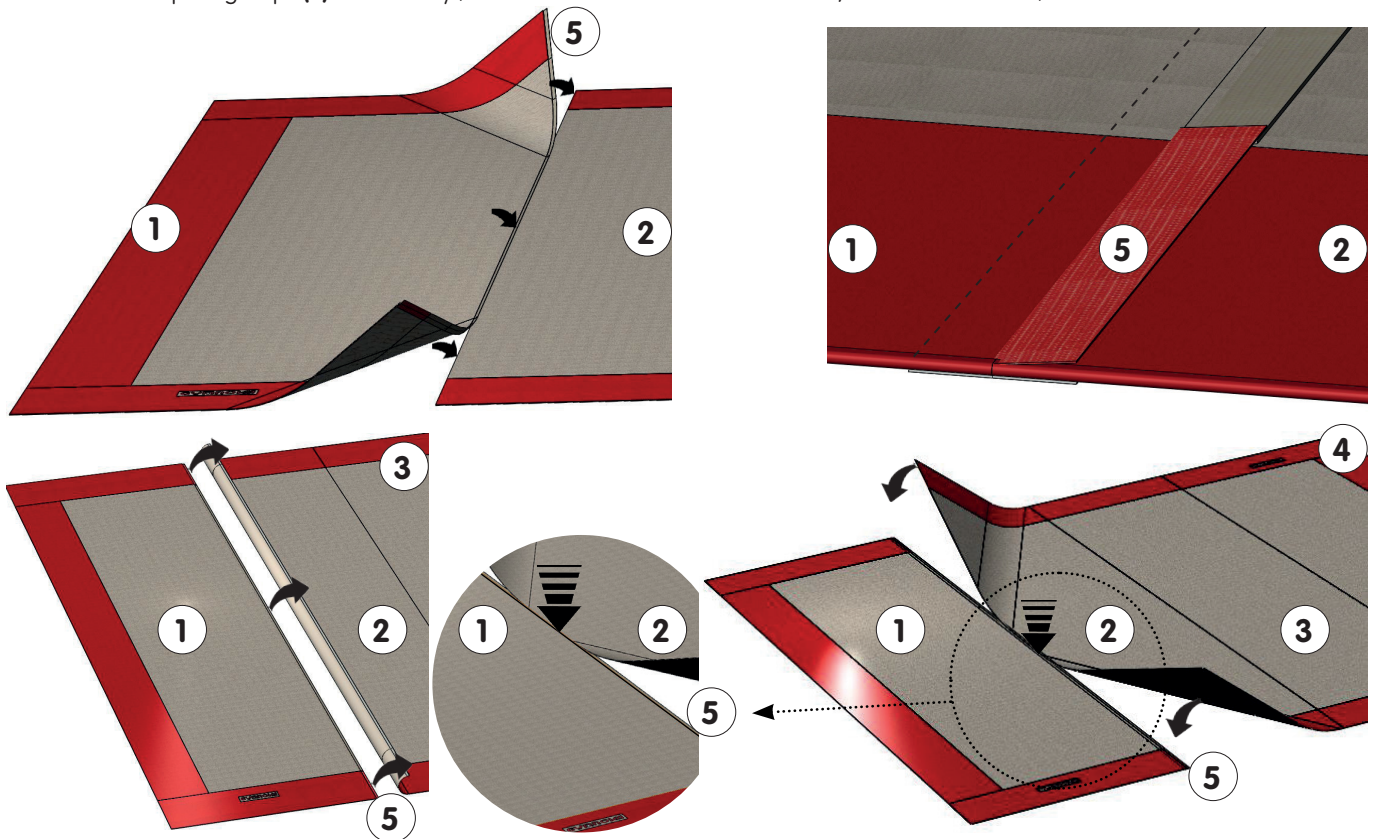

6/ INSTALLATION OF THE CARPET ANTI-ROTATION KIT (8) UNDER THE ENDS OF THE CENTRAL WIDTHS (2) AND (3) (SEE FIG. 14 OPPOSITE).

- Fold back each end of the carpet to expose the black strips (7) underneath the central widths.
- If they are in poor condition, replace them with the ones provided.
- Attach a 2.50 m beige adhesive hook-and-loop strip (6) centred on the width of each black strip (7).
- Remove the protective film from the self-adhesive surface of the hook-and-loop strip (6) and apply the ends of the carpet onto the foam. Press firmly.

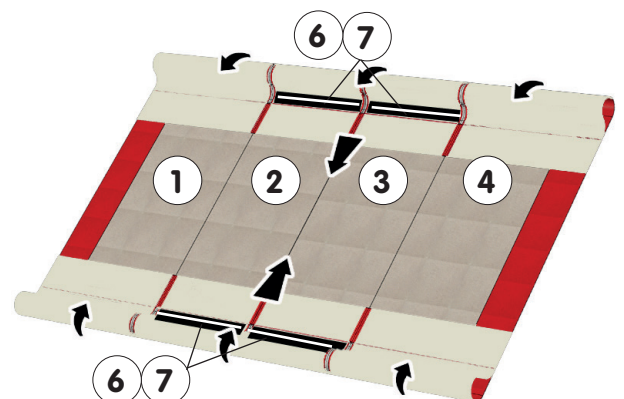

IV. Disassembly and storage of carpet: minimum.

1 / DISASSEMBLY (SEPARATING THE 4 WIDTHS):

- Start by connecting a side width (1) and the central width (2).
- Proceed in the same way for the side width (4) and central width (3).
- Repeat the process between the 2 central widths (2) and (3).

Figure 15 - Separation of 2 widths

- Position yourself at a joint between 2 widths and carefully lift the corner of a side width (1), while holding the corner of the corresponding central width (2): stand on this width, then walking along the join.
- Work in this way up to halfway along the length of the carpet, then repeat this process from the other end: the first side width (1) is now free.

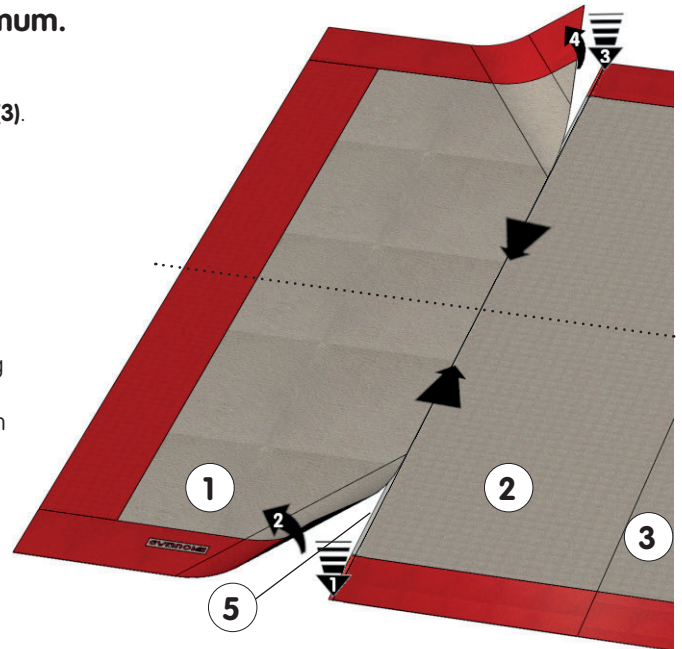

Figures 16 - 17 - Disassembly the joining strip

- Fold back the edge of the central width (2) to release the hook-and-loop joining strip (5).
- Gradually lift the joining strip (5) while keeping the carpet on the floor: standing on the edge of the central width (2), then walking along.

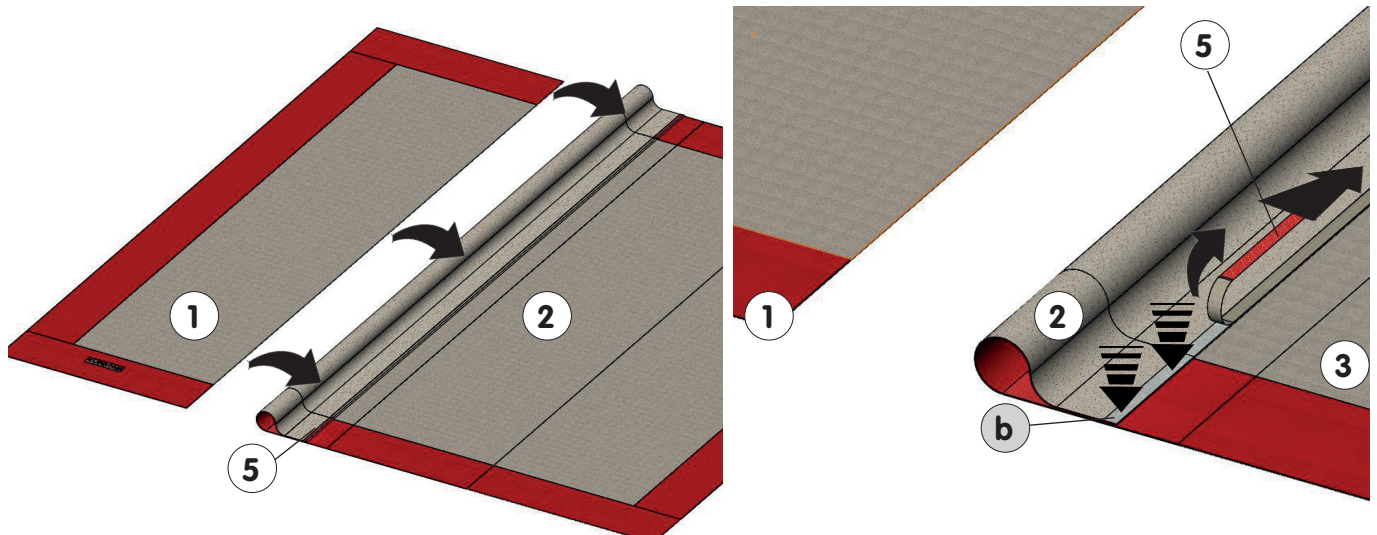

2/ ROLLING THE 4 WIDTHS BEFORE STORAGE:

 **IMPORTANT: THE CARDBOARD CORE TUBE USED MUST PROTRUDE BEYOND EACH END OF THE CARPET WIDTH.**

- Place the 4 widths as flat as possible to facilitate even rolling (do not form a "cone" shape) and to ensure the carpet is stored in good condition.

Figures 18 - 19 - Rolling method

- With 2 people (without a reel trolley), position the cardboard core tube (a) parallel at one end of the first side width (1).
- Roll up the carpet moving forward together at the same time in order to obtain an even cylinder. This will enable the carpet to be stored without damage.
- Repeat the process for the 3 remaining widths.

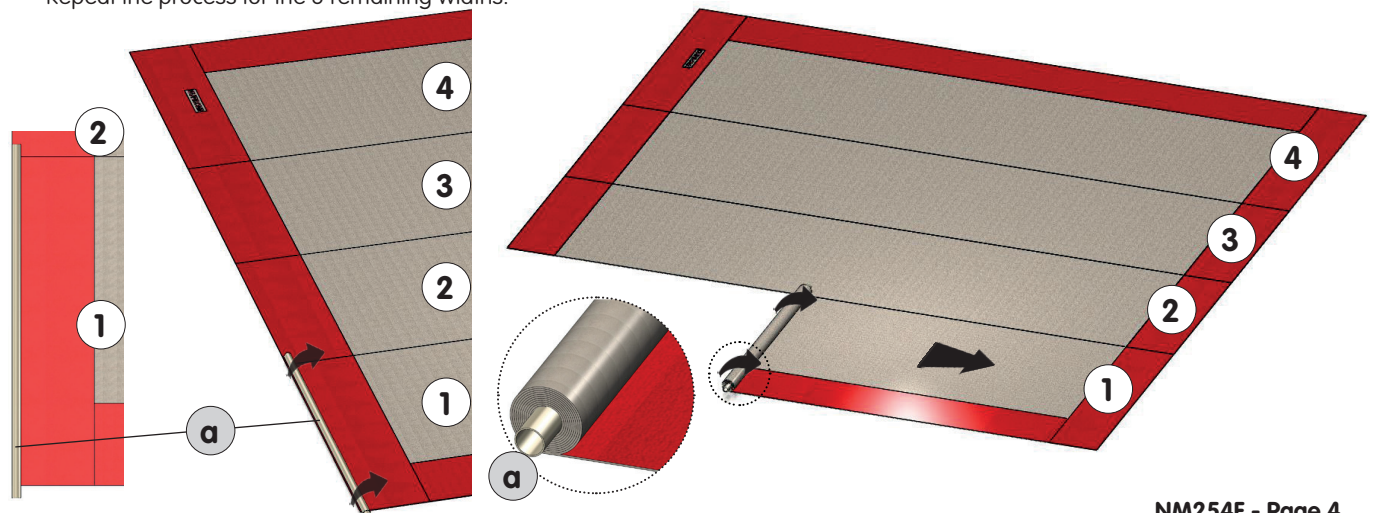

V. Maintenance:

- Regular cleaning of the exercise floor makes it easier to spot any problems (distortion, breakage or moisture absorption).
- Check the condition: of the different carpet widths **(1)**, **(2)**, **(3)** and **(4)** (red edges securely attached to the beige central section, 5cm white hook-and-loop strips **(b)** under the edges of the widths (see Fig 17), the 8 parts of the carpet Anti-Rotation Kit **(8)** and the hook-and-loop joining strip **(5)**.
- For any questions on cleaning the carpet, refer to the recommendations below.
- Check the condition of the "concertina" foam tracks (see NM253, NM299) and the hook-and-loop joining strips **(5)** and the floor (wood & foam blocks - see NM06 or wood & springs - see NM257, NM273 or NM274).
- Any damaged or distorted component should be replaced as quickly as possible.
- If creases appear: remove the joining strips(s) **(5)** from the corresponding width(s) following instructions § IV 1/, and flatten the surface with a cardboard tube **(a)** in the direction of the hair evenly. Allow the carpet to flatten completely, before reinstalling the links according to § III 5/.

VI. Maintenance recommendations:

Maintenance is an essential element in ensuring long life of the carpet. This document gives recommendations on maintenance, stain removal and cleaning for preservation of a high-quality appearance all through the equipment's life.

 **INADEQUATE CLEANING AND IN PARTICULAR USE OF INAPPROPRIATE STAIN REMOVERS OR DETERGENT SOLUTIONS CAN QUICKLY LEAD TO IRREPARABLE DILAPIDATION OF THE CARPET. IN SUCH SITUATIONS, GYMNOVA SHALL NOT ACCEPT ANY LIABILITY.**

Effective maintenance of the carpet MUST include 4 types of actions:

- Protection of accesses
- Dust removal
- Stain removal
- Periodic cleaning

1/ PROTECTION OF ACCESSES: SINCE THE MAIN CAUSE OF SOILING IS DUST AND DEBRIS FROM THE OUTSIDE, PREVENTIVE MEASURES CONSIST IN PROTECTING ALL ENTRANCES TO THE GYMNASIUM.

2/ DUST REMOVAL BY BRUSH-VACUUMING: REGULAR CLEANING WITH A BRUSH-VACUUM CLEANER IS THE PRIMARY MAINTENANCE MEASURE FOR THE CARPET. TO BE EFFECTIVE, IT IS ABSOLUTELY NECESSARY TO USE A VACUUM WITH A ROTATING BRUSH FOR OPTIMAL DUST REMOVAL BY MECHANICAL MEANS, WITHOUT HAVING TO PUSH DOWN WHEN USING THE VACUUM.

3/ STAIN REMOVAL: MUST BE PERFORMED DAILY. STAINS GET MUCH HARDER TO REMOVE WHEN THEY BECOME OLD. PROCEED AS FOLLOWS:

- Liquid stains: As quickly as possible, absorb any spilled liquid by dabbing with a clean, dry and absorbent white cotton cloth. **Do not rub the stain.**
- Solid stains: Remove as much as possible with a knife.
- All stain types:
 - Use the stain removal table below to identify the right stain removal product.
 - Before any cleaning, check that the stain removal agent is "compatible" with the carpet by testing it on an unexposed area.
 - Apply the stain removal product on a white cotton cloth (never directly on the carpet) and dab the stain firmly but without rubbing. Work on the stain from the outside towards the centre to prevent it spreading.
 - Continue to use the stain removal product as described above for as long as it takes for the stain to come out into the cloth.
 - For shampoo-based mixtures, the overturned glass method can be used effectively to massage the stain by making circles with the overturned glass and then collecting any resulting foam in the glass. Repeat the process without adding any product until no more foam is formed.
 - Once the stain is removed, rinse it with clean water by dabbing several times with a damp sponge. Dab with a dry cloth to absorb all the liquid. Warning: some cleaning solutions can give rise to rapid re-soiling if they are not completely removed.
 - Lastly, to absorb residual dampness, place a white, lint-free absorbent layer (cotton cloth or kitchen towel) about 1 cm thick under a heavy object protected with plastic film.
 - After removal of the object, vacuum-brush the area.

4/ PERIODIC CLEANING:

When these operations are properly carried out they can defer the need for more time-consuming operations such as « Major cleaning » or « Renovation ».

- Cleaning using absorbent powder:
 - Spray pre-stain removal solution over max. 10 m² sections at a time concentrating on dirty or stained areas.
 - Then spread the powder into a layer as thin as possible.
 - Use a broom or equivalent to push the powder into the carpet. Leave the product to work for 1 to 3 hours.
 - Remove the powder with a brush-vacuum, passing the vacuum over several times if necessary, without exerting any vertical pressure.
- Injection Extraction :

 **WARNING: THIS VERY COMPLEX METHOD IS A DEEP CLEANING METHOD FOR CLEANING THE FIBRES FROM TOP TO BOTTOM AND SHOULD ONLY BE CONSIDERED FOR EXTREME CASES OF SOILING. FIRSTLY, CAREFULLY REMOVE ALL DUST FROM THE AREA TO BE TREATED.**

The principle of this method is injection of a very dilute solution of detergent in warm or hot water in the case of very greasy soiling which will loosen the dirt. Immediately afterwards, a very powerful wet-suction system extracts the water together with the dirt.

It is important to take care when selecting the detergent solution. **The pH of these solutions MUST be less than 8.**

As a precaution, an anti-foaming agent should be added to the machine's extraction tank.

THESE STEPS SHOULD BE FOLLOWED:

- Proceed using parallel passes. Only use the detergent solution in sufficient quantities to ensure effective cleaning.
- Avoid excessive wetting. Clean in straight lines when possible and overlap each pass by one third of the width of the cleaning nozzle to prevent any residual machine marks.
- After each clean, immediately make a second pass over the same surface without detergent, but operating the vacuum.
- Extraction should be repeated on areas where visible dirt has not been removed by means of a single pass of the cleaning nozzle.
- Next, the same operations should be carried out with water instead of detergent so as to remove all traces of detergent from the carpet pile.
- If extraction has been correctly performed, the optimal drying time is around 6 to 12 hours. Avoid any foot traffic on the carpet during this period. This time period can be significantly reduced by using special blow dryers.

IMPORTANT GENERAL RECOMMENDATIONS:

The carpets are sensitive to chemicals: the fibres in the wear layer and the back of the carpet can be damaged by aggressive agents such as alkaline products (ammonia, etc.), bleaching agents, oxidizing agents (liquid bleach, hydrogen peroxide, etc.) and reducing agents.

⚠️ AVOID SATURATING THE STAIN: PROLONGED OR REPEATED WETTING CAN CAUSE DISCOLOURATION, SOFTENING OR DETACHMENT OF THE BACK, SHRINKAGE, YELLOWING OF THE CARPET OR ENCOURAGE GROWTH OF MOULD AND BACTERIA.

STAIN REMOVAL TABLE*

Type of stain	Actions
Butter, oil, fat, tar, grease, polish	<ul style="list-style-type: none"> - Start by removing as much as possible with a knife. - Dab with a cloth moistened with petroleum type solvent - Then apply an absorbent powder. - Rinse with clean water - Dry and vacuum.
Alcoholic beverages, coffee, tea, soda, fruit juice	<ul style="list-style-type: none"> - After removal of as much as possible with absorbent cloths, - Dab the stained areas (working from the outside towards the centre) with an equal parts solution of water and alcohol. - Then rinse with clean water.
Mud	<ul style="list-style-type: none"> - Leave the mud to dry, then brush. - If necessary, rub with a carpet shampoo solution. - Rinse with clean water.
Candle wax	<ul style="list-style-type: none"> - Remove as much candle wax as possible by lightly scraping. - Then place blotting paper on the stain and apply a warm iron without pressing down. - Repeat, moving the blotting paper, until the wax stain has melted and is mostly absorbed. - Finish by rubbing the stain with a cloth moistened with an alcohol cleaner.
Chewing-gum	<ul style="list-style-type: none"> - Harden the chewing gum with ice - Remove it using the back of a knife blade. - Then dilute what remains with acetone.
Milk, egg, yogurt, chocolate, grass, vomit	<ul style="list-style-type: none"> - Rub with a cloth moistened with hot water and biological washing powder. - Rinse with clean water.
Glue, varnish	<ul style="list-style-type: none"> - Remove as much of the glue or varnish as possible - Then dab with a cloth soaked in acetone.
Paint	<ul style="list-style-type: none"> - Scrape the paint with sandpaper - Then dab with a cloth moistened with acetone.
Lipstick	<ul style="list-style-type: none"> - Clean with a cloth moistened with makeup remover then with a carpet shampoo solution. - Rinse with clean water.
Rust	<ul style="list-style-type: none"> - Dab the stained area with a commercial rust remover. - Before applying, test on an inconspicuous corner of the carpet to make sure it does not cause any discolouration. - Leave to work. - Rinse with clean water.
Blood, milk, sweat, urine	<ul style="list-style-type: none"> - Ammonia solution (28%) or hydrogen peroxide solution (30%).
Nail varnish	<ul style="list-style-type: none"> - Dab the stain with a cloth moistened with acetone or amyl acetate.
Unknown stain	<ul style="list-style-type: none"> - Dab successively with methylene chloride, then acetone, then a dilute white vinegar solution, - Clean with a carpet shampoo. - Rinse with clean water.

* **Remember:** remover must be applied on a clean cloth, NEVER directly on the carpet.

14 x 14m Complete carpet
(Ref.: 6380H)

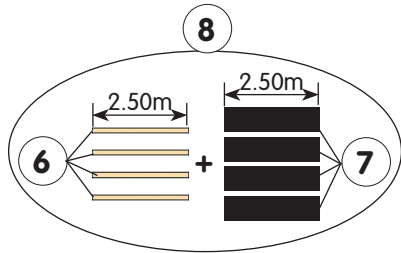
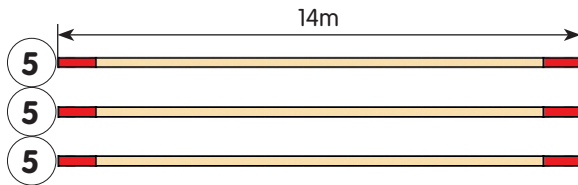
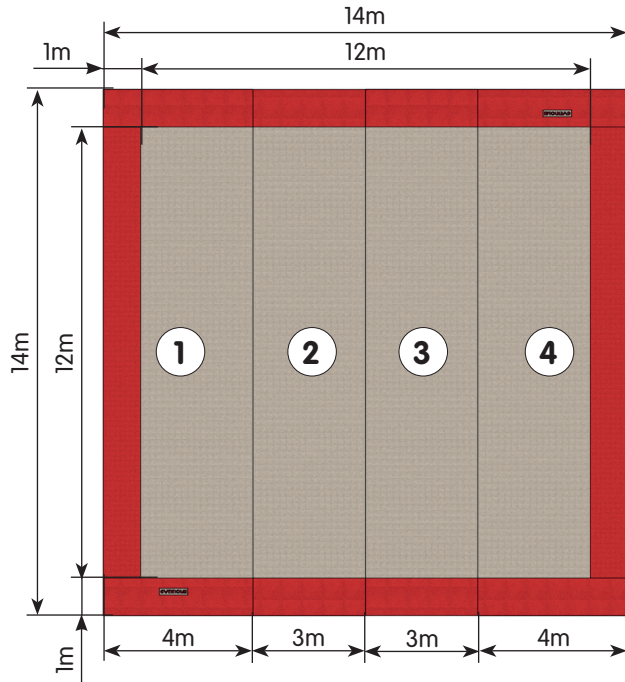

13.05 x 13.05m Complete carpet
(Ref.: 6390I)

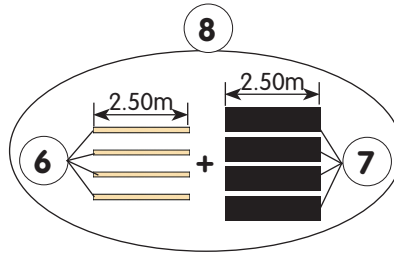
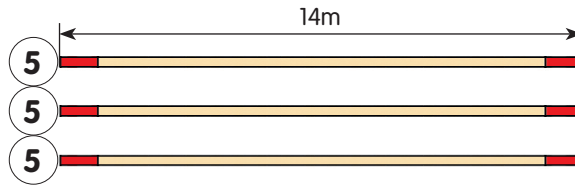
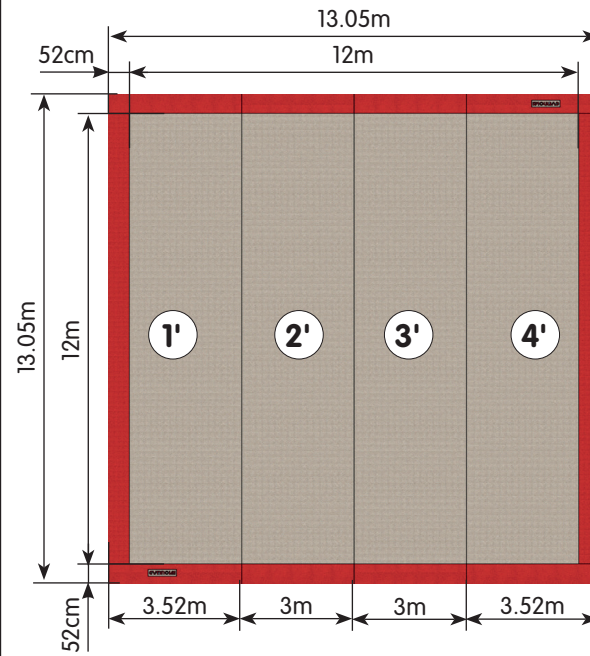

26	-	-	-	-
25	-	-	-	-
24	-	-	-	-
23	-	-	-	-
22	-	-	-	-
21	-	-	-	-
20	-	-	-	-
19	-	-	-	-
18	-	-	-	-
17	-	-	-	-
16	-	-	-	-
15	-	-	-	-
14	-	-	-	-
13	-	-	-	-
12	-	-	-	-
11	-	-	-	-
10	-	-	-	-
9	-	-	-	-
8	1	Carpets Anti-Rotation Kit	6532B	-
7	4	2.50m x 25cm Black adhesive strip	-	Include in 2, 3 & 6
6	4	2.50m x 5cm Beige adhesive strip	-	Include in 8
4'	1	13.05 x 3.52 m Right side width No. 4	6390/144	Ex. Floor 13 x 13m
3'	1	13.05 x 3 m Central width No. 3	6390/143	Ex. Floor 13 x 13m
2'	1	13.05 x 3 m Central width No. 2	6390/142	Ex. Floor 13 x 13m
1'	1	13.05 x 3.52 m Left side width No. 1	6390/141	Ex. Floor 13 x 13m
5	3	14 m Joining strip, beige / red	-	Unit
4	2	14 x 4 m Right side width No. 4	6380/144	Ex. Floor 14 x 14m
3	1	14 x 3 m Central width No. 3	6380/143	Ex. Floor 14 x 14m
2	1	14 x 3 m Central width No. 2	6380/142	Ex. Floor 14 x 14m
1	1	14 x 4 m Left side width No. 1	6380/141	Ex. Floor 14 x 14m
ITEM	QTY	DESCRIPTION	REFERENCE	REMARKS

**14x14M & 13x13M OVERLAY CARPETS
AND ARTISTIC GYMNASTICS EXERCISE FLOORS**

To order spare parts, please provide the description, reference and delivery date of the entire apparatus.

Constantly aiming to improve our products, we reserve the right to make changes to the equipment and dimensions without further discussion.

This document is the propriety of Gymnova, it is confidential and shall not be reproduced.

14x14M & 13x13M FOAM AREAS «MONTREAL» EVOLUTION COMPETITION & TRAINING SPRINGS EXERCISE FLOOR WITH CARPETS M'20

6788B
6775D - 6775D/DE
6784B
6777D - 6777D/DE



6775D - 6775D/DE

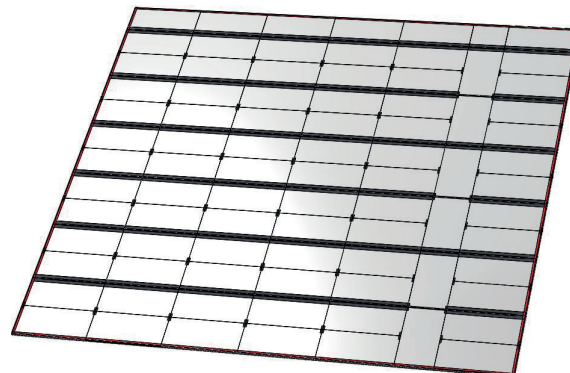
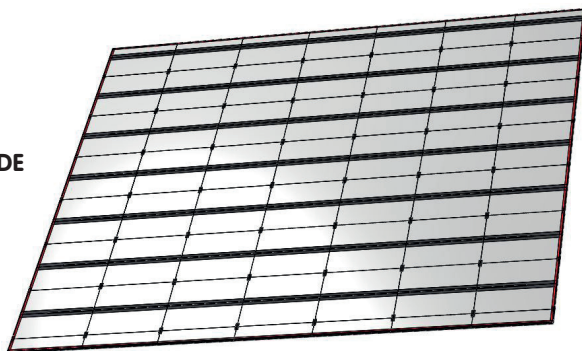

**KEEP THIS
DOCUMENT**

Warning:

This equipment should be installed by a qualified individual. This equipment should only be used by one person at a time, under the supervision of a qualified individual.

Using this equipment for purposes other than those originally intended is prohibited.

Compliance:

14 x 14 m Exercise floors references **6775D et 6775D/DE** are FIG approved.

Recommendations:

- Keep these instructions for subsequent reference (inspection, maintenance, etc.).
- Periodically carry out predictive maintenance.
- Depending on how much it is used have the equipment serviced yearly or every few years.

Pack list:

PACK REF.	6542/00 7 joining strips 12.50m for foam tracks	6586/10 Foam Anti-Rotation Kit M13	6588/20 Bib retention kit & RG marking	6788/60 Foam track 14 x 2m th. 56mm	6788/62 Set of 2 foam tracks 14 x 2m th. 56mm	6784/71 Foam track 13 x 2m th. 56mm	6784/72 Set of 2 foam tracks 13 x 2m th. 56mm	Number of packages
6788B Foam 14 x 14m th.: 56mm	1	1	1	1	3	-	-	7
6784B Foam 13 x 13m th.: 56mm	1	1	1	-	-	1	3	7
VOLUME (M³)	0.02	0.01	0.01	2.22	3.86	0.88	3.54	X
WEIGHT (KG)	2.1	1.3	3	65	131	26	116	
SIZE (MM)	360x260x180	350x250x150	300x200x200	2000x1000x1100	2000x1000x1930	2000x1000x440	2000x1000x1770	

I. Maintenance:



IMPORTANT :

Leave the foam to rest for at least 48 h. If the foam area (centred) overlaps the floor: cut off any excess foam around the entire perimeter of the foam area. Repeat the process if necessary (foam dimensions vary over time).

- Regular cleaning of the exercise floor makes it easier to spot any problems (distortion, breakage or moisture absorption).
- Check the condition of the foam mats **(1)** or **(2) & (3)**, the joining strips **(4)**, the Bib retention kit **(5)** and of their anti-rotation kit **(6)**.
- Check the condition of the floor (wood panels, springs, plastic parts, sections and plates - **NM273 or NM274**) and the overlay carpet **(NM254)**.
- Any damaged or distorted component should be replaced as quickly as possible.

II. Disassembly and storage of the foam:

- Carefully roll up the joining strips **(4)**.
- Cut the bib retention strips **(5)** at the junction of the foam tracks, then fold the 7 foam tracks **(1)** or **(2) & (3)**.
- Store flat stacked foams in a clean, dry place. Do not store any heavy, protruding or other item on top. Avoid direct contact with the floor.

III. Assembling the floor of the exercise floor 14x14m or 13x13m (Refs.: 6785A - 6787A or 6781A - 6783A):
 Refer to the instructions in **NM273** or **NM274**. For installing the anti-rotation kit, refer to instructions **NM277**.

IV. Assembling the impact-absorbing foam area (Refs.: 6788B or 6784B)  minimum:

Figures 1 & 2 - Installing the Anti-Rotation Kit of the foam area

- Brush and vacuum carefully if necessary the hook-and-loop (**a**) located on the 4 corner plates of the floor.
- Place each of the 4 strips of 150 x 25 cm black textile adhesive (**6**) on each self-gripping pad (**a**) on the floor corners.
- **Important:** wait the end of step **IV**, to remove the protective film from the 4 strips (**6**)



14 x 14m Floor

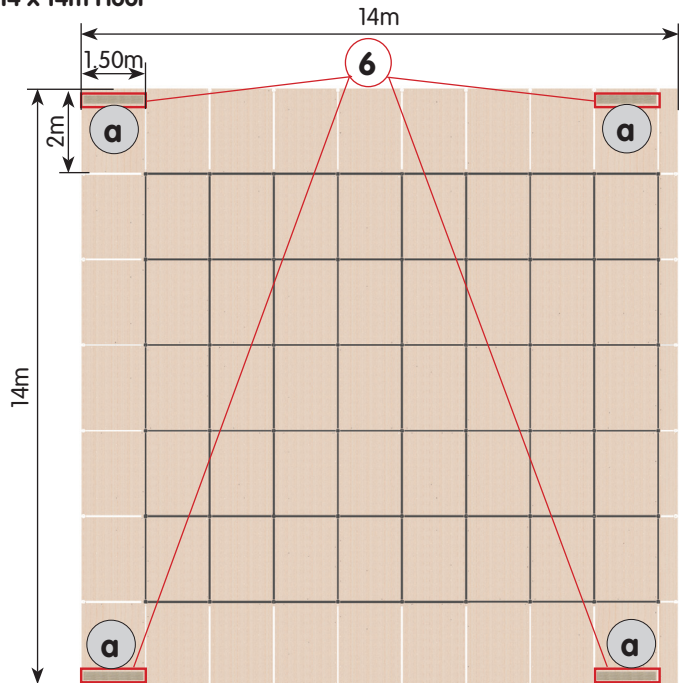

13 x 13m Floor

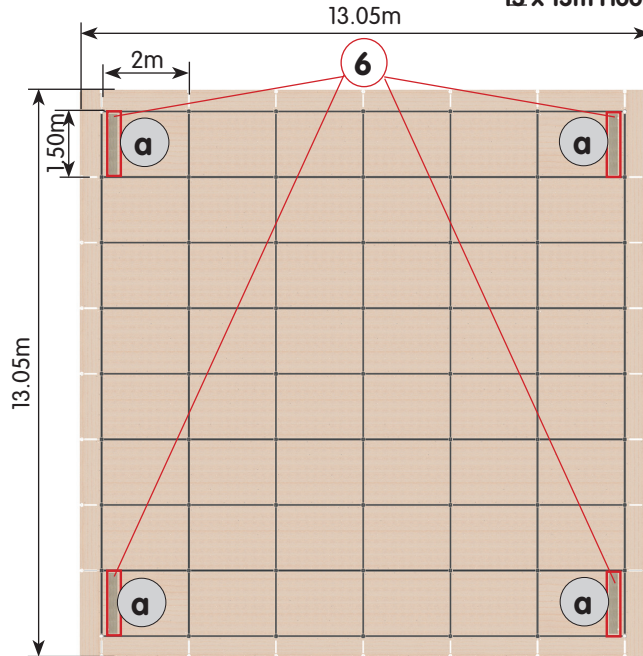

Figures 3 & 4 - Installing the foam area

- Unfold the foam tracks (**1**) or (**2**) & (**3**), with the darker surface facing the floor, with respect to the arrangement of the floor plates, while respecting their orientation to align the black textile hinges.
- Align and centre these foam tracks relative to the edges of the floor.

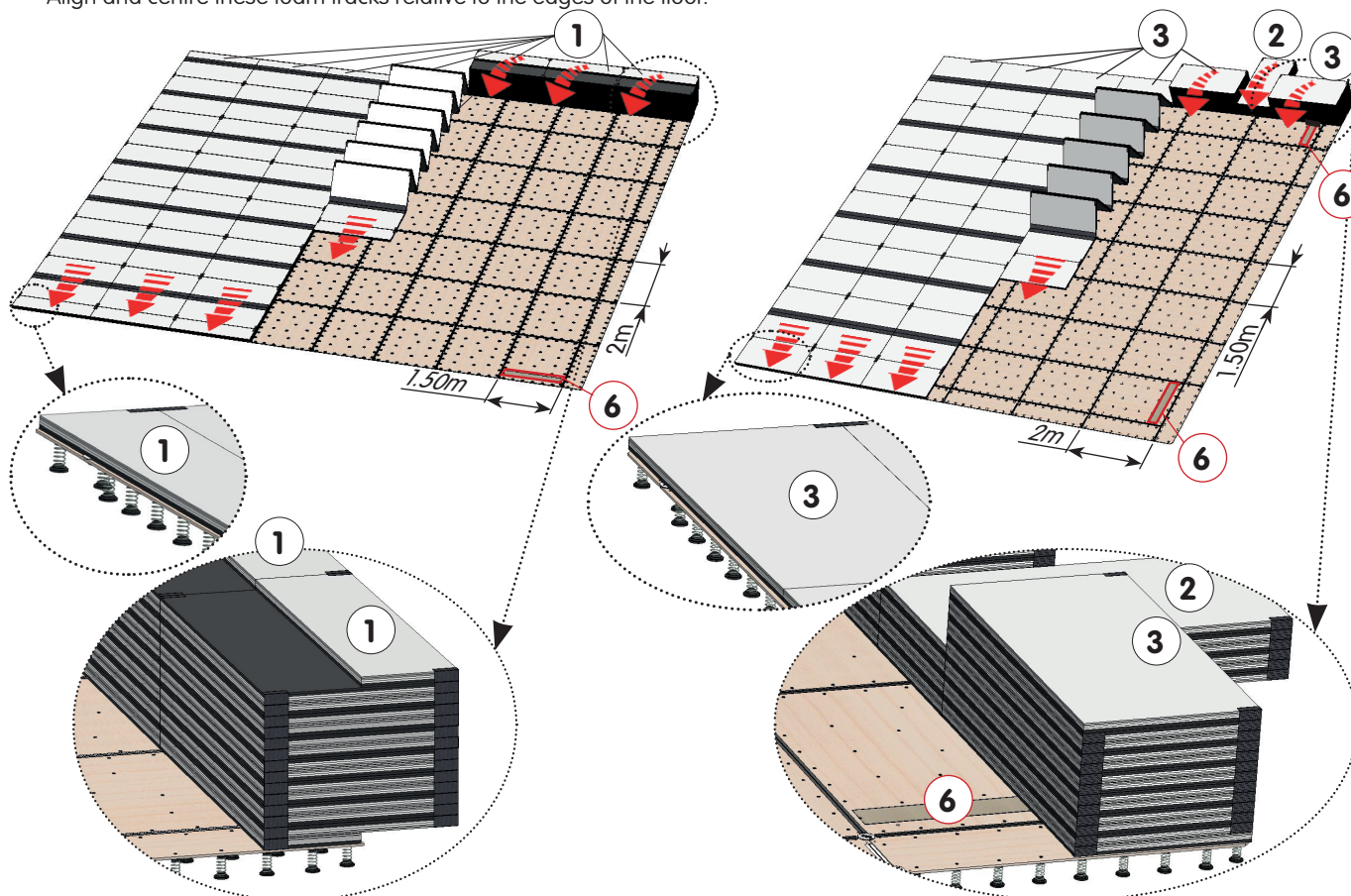

Figures 5 & 6 - Binding the foam area

- Lock the assembly together using the 7 joining strips (4) (length 12.5 m - width 5 cm) to be centred on the black fabric strips.
- Attach one end, extend the strip (4) over the 12.5 m and position the other end.
- Press with your hand along the full length of the strip to check it is attached to the black fabric and to strengthen this attachment.
- Carefully lift the foam at the 4 corners, remove the protective film from the 4 strips (6) and replace the foam tracks).
- Press firmly on each foam track to join the components securely.

14 x 14m Foam area

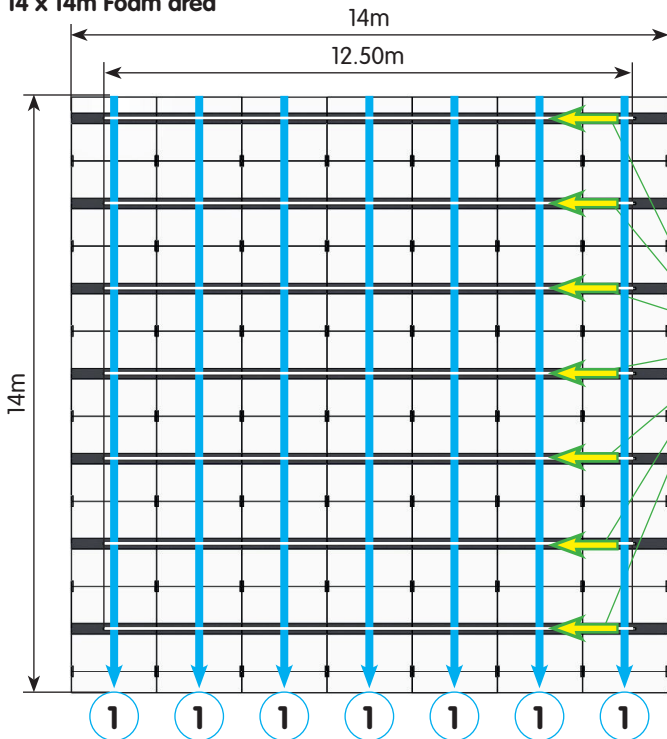

13 x 13m Foam area

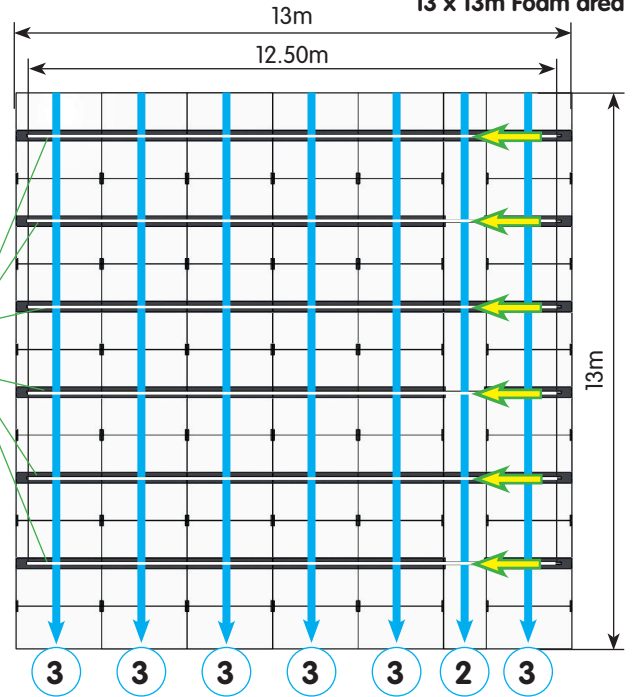

Orientation of foam tracks (in blue) / Orientation of joining strips (in green / yellow)

Figures 7 & 8 - Installing the finishing bibs retention kit

- Unroll, cut and lay 4 lengths of adhesive red velvet (5cm wide) from the bibs retention kit (5), all around the periphery 2cm from the edge of the foam area (4 x 14m ou 4 x 13m).

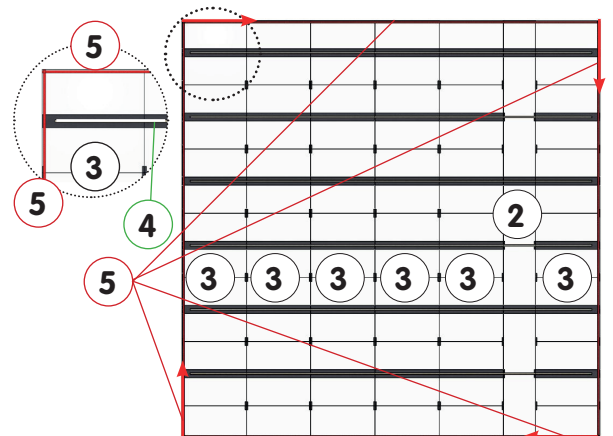
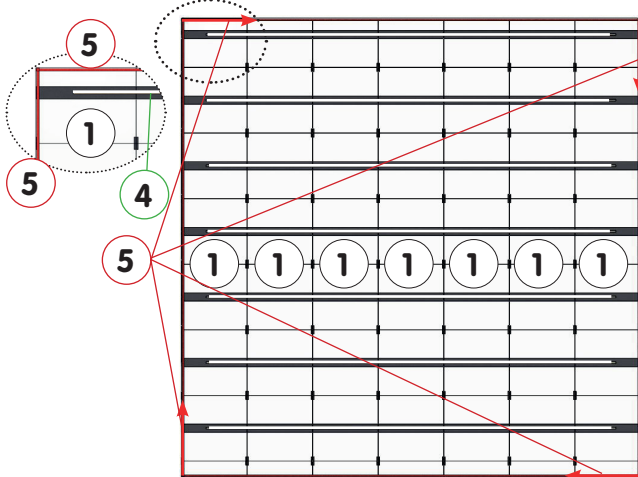

Figures 9, 10 & 11 - Installing the finishing bibs

- Align the corner of the bib (7) or (8) (in a "V") over the corner of the foam.
- Then attach the bib (7) or (8) to the strip (5), on the band of Velours, pressing it as and when.
- Repeat the process for the 3 remaining bibs (7) or (8). Join the bibs together: the large side goes over the smaller side.

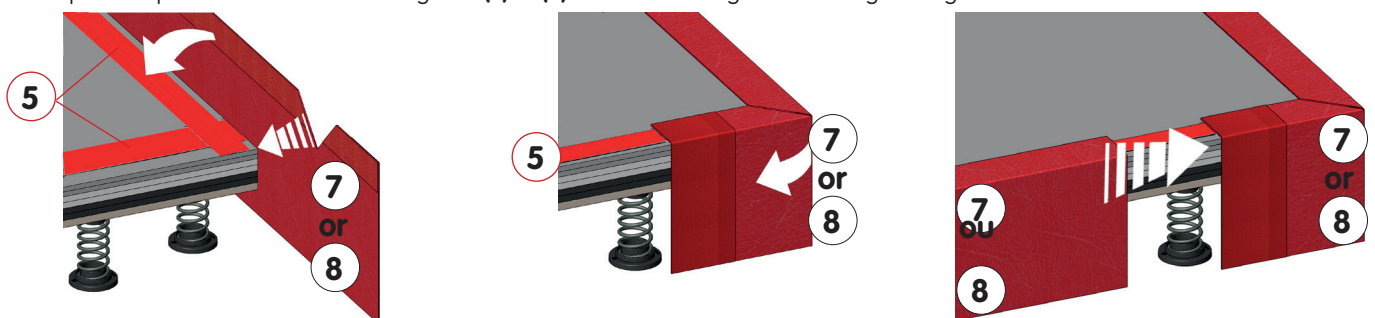

V. Assembling the gymnastics overlay carpet (Refs: 6380H or 6390I): Refer to assembly instructions in NM254.

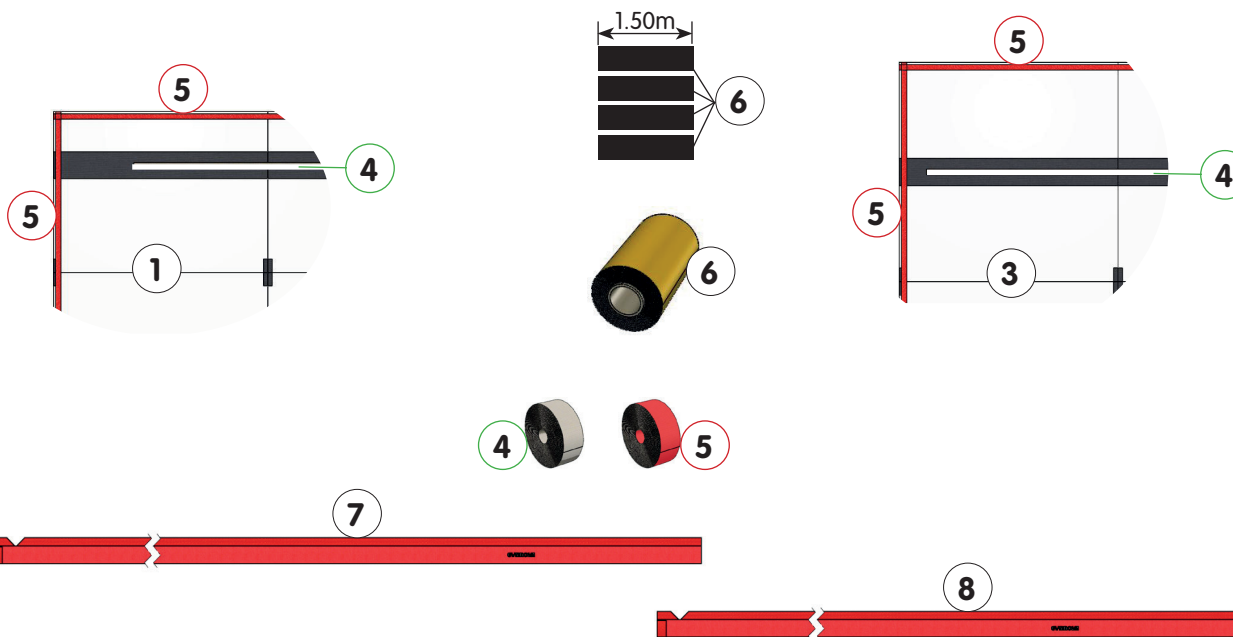
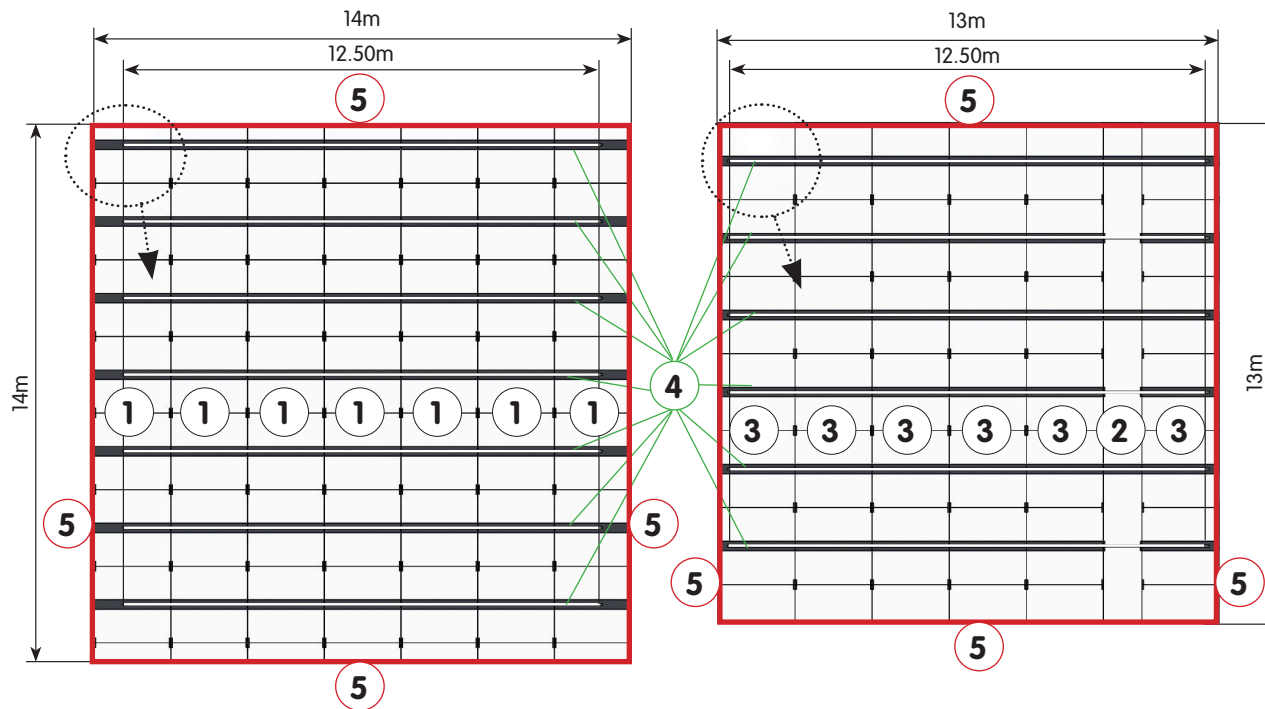

30	-	-	-	-
29	-	-	-	-
28	-	-	-	-
27	-	-	-	-
26	-	-	-	-
25	-	-	-	-
24	-	-	-	-
23	-	-	-	-
22	-	-	-	-
21	-	-	-	-
20	-	-	-	-
19	-	-	-	-
18	-	-	-	-
17	-	-	-	-
16	-	-	-	-
15	-	-	-	-
14	-	-	-	-
13	-	-	-	-
12	-	-	-	-
11	-	-	-	-
10	-	-	-	-
9	-	-	-	-
8	-	Set of 4 x 13m finishing bibs	6577/00	6777D-6777D/DE
7	-	Set of 4 x 14m finishing bibs	6575/10	6775D-6775D/DE
6	1	Foam Anti-rotation Kit	6586/10	6775D-6777D
5	1	Bib retention kit	6788/20	6775D-6777D
4	1	Set of 7 joining strips of 12.50m	6542/00	6775D-6777D
3	6	13 x 2m th.56mm Foam track	6784/70	6777D-6777D/DE
2	1	13 x 1m th.56mm Foam track	6784/71	6777D-6777D/DE
1	7	14 x 2m th.56mm Foam track	6788/60	6775D-6775D/DE
ITEM	QTY	DESCRIPTION	REFERENCE	REMARKS

14x14M & 13x13M FOAM AREAS
«MONTREAL» EVOLUTION COMPETITION & TRAINING
SPRINGS EXERCISE FLOOR WITH CARPETS M'20

To order spare parts, please provide the description, reference and delivery date of the entire apparatus.

Constantly aiming to improve our products, we reserve the right to make changes to the equipment and dimensions without further discussion.

This document is the propriety of Gymnova, it is confidential and shall not be reproduced.

14 x 14M THICKNESS 14CM SPRUNG FLOORS WITH MOUNTED & NOT MOUNTED SPRINGS «MONTREAL» EVOLUTION COMPETITION EXERCISE FLOOR M'20

6785A - 6787A
6775D - 6775D/DE
6776C - 6776C/DE



6775D & 6775D/DE
6776C & 6776C/DE

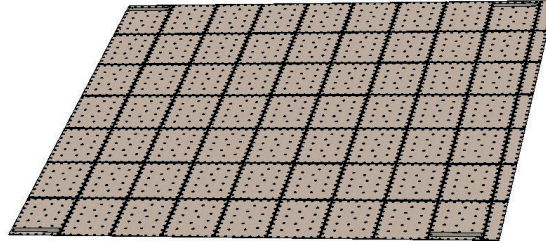

**KEEP THIS
DOCUMENT**

Warning:

This equipment should be installed by a qualified individual. This equipment should only be used by one person at a time, under the supervision of a qualified individual.

Using this equipment for purposes other than those originally intended is prohibited.

Compliance:

14 x 14 m Exercise floors references **6775D - 6775D/DE et 6776C - 6776C/DE** are FIG approved.

Recommendations:

- Keep these instructions for subsequent reference (inspection, maintenance, etc.).
- Periodically carry out predictive maintenance.
- Depending on how much it is used have the equipment serviced yearly or every few years.

Maintenance:

IMPORTANT :

- Regular cleaning of the exercise floor makes it easier to spot any problems (distortion, breakage or moisture absorption).
- Check on the presence and condition: of the profiles **(8), (9), (10), (11) & (12)** and linking plates **(13) & (14)** properly locked.
- Check the condition of the floor: wood panels **(4), (5), (6) & (7)**, springs **(2)** and plastic parts **(1) & (3)**,
- Check the condition of the floor anti-rotation kit **(NM277)**.
- Check the condition of the foams area **(NM285 or NM299)**, and the carpet **(NM254)** or roll-up tracks **(NM286)**.
- Any damaged or distorted component should be replaced as quickly as possible.

Composition :

1/ 14 x 14M «MONTREAL» EVOLUTION COMPETITION EXERCISE FLOOR WITH MOUNTED & NOT MOUNTED SPRINGS CARPET VERSION (REF.: 6775D & 6775D/DE):

- Overlay carpet 14 x 14m (Ref: 6380H) -> Detailed Pack list: refer to instructions NM254.
- Set of 4 finishing bibs 14m (Ref: 6575/10): Volume 0.06 m³, Weight 9.5 kg, Dimensions 600 x 420 x 240 mm -> instructions NM299.
- Impact-absorbing foam area 14 x 14m - thickness: 56 mm (Ref: 6788B) -> Detailed Pack list: refer to instructions NM299.
- High elasticity floor 14 x 14m with springs mounted (Ref: 6785A) or springs not mounted (Ref: 6787A).
- Floor Anti-Rotation Kit - 4 adjustable cables (Ref: 6529/00) -> Detailed Pack list: refer to instructions NM277 (included in floor).

2/ 14 x 14M «MONTREAL» EVOLUTION COMPETITION EXERCISE FLOOR WITH MOUNTED & NOT MOUNTED SPRINGS ROLL-UP TRACKS VERSION (REF.: 6776C & 6776C/DE):

- Gymnastics Area 14x14m th. : 3.8cm «Montreal» evol. Comp. Exercise floor M'20 (Ref.: 6776/00) -> Detailed Pack list: refer to instructions NM286.
- Set of 4 finishing bibs 14 m (Ref: 6575/10): Volume 0.06 m³, Weight 9.5 kg, Dimensions 600 x 420 x 240 mm -> instructions NM286.
- Foam underlay 14x14m thickness: 24mm Exercise floor M'20 (Ref.: 6776/10) -> Detailed Pack list: refer to instructions NM285.
- High elasticity floor 14 x 14 m with springs mounted (Ref: 6785A) or springs not mounted (Ref: 6787A).
- Floor Anti-Rotation Kit - 4 adjustable cables (Ref: 6529/00) -> Detailed Pack list: refer to instructions NM277 (included in floor).

Pack list:

PACKAGES REF.	6529/00 Floor ARK Ex. Floor M'12	6785/80 Pallet 21 panels + 7 edges	6785/90 Pallet 19 panels + 2 corners	6585/19 Set 12 profiles White Length 30 cm	6785/15 Set 8 prof. White Length 1.3 m	6785/16 Set 30 prof. Grey Length 1.4 m	6785/17 Set 20 prof. White Length 1,8m	6785/18 Set 29 prof. Grey Length 1,9m	6785/60 Pack 66 plates White/Grey	6785/70 Pack 34 plates White	6785/100 Pack 5 springs + fixings	Nber of pack.
6785A High elasticity floor 14 x 14 m springs mounted	1	1	2	1	1	2	1	2	1	1	1	14
VOLUME (m³)	0.013	6.5	5.5	0.002	0.01	0.03	0.02	0.03	0.03	0.03	0.005	X
WEIGHT (KG)	4.2	836	758	2	4	15	15	22	3.64	2	1.2	
SIZE (MM)	310x210x200	2020x1510x2130	2020x1510x1820	310x150x50	1300x170x50	1400x170x110	1800x170x80	1900x170x80	410x320x230	400x310x230	200x160x150	

PACKAGES REF.	6529/00 Floor ARK Ex. Floor M'12	6787/40 Pallet 32 panels + edges	6787/50 Pallet 27 panels + 4 corners	6585/19 Set 12 prof White Len- gth 30 cm	6785/15 Set 8 prof. White Length 1,3m	6785/16 Set 30 prof. Grey Length 1.4 m	6785/17 Set 20 prof White Len- gth 1,8m	6785/18 Set 29 prof. Grey Length 1,9m	6785/60 Pack 66 plates White/Grey	6785/70 Pack 34 plates White	6787/20 Pack 113 springs only	6787/30 Pack 1356 lower supports	6785/100 Pack 5 springs + fixings	Nber of pack
6787A High elasticity floor 14 x 14 m springs not mounted	1	1	1	1	1	2	1	2	1	1	24	2	1	39
VOLUME (m³)	0.013	3.21	2.87	0.002	0.01	0.03	0.02	0.03	0.03	0.03	0.05	0.21	0.005	X
WEIGHT (KG)	4.2	982	909	2	4	15	15	22	3.64	2	20.2	20	1.2	
SIZE (MM)	310x210x200	2030x1520x1040	2030x1520x930	310x150x50	1300x170x50	1400x170x110	1800x170x80	1900x170x80	410x320x230	400x310x230	360x360x360	1300x600x270	200x160x150	

I. Assembling the floor not mounted springs (Ref.: 6787A) of exercise floors Refs.: 6775D/DE & 6776C/DE :

Figures 1 & 2 - Clipping of springs and lower supports under floor panels

- Align vertically: the lower support (1), the spring only (2) and the upper support (3) screwed to the floor panels (p).
- Press hard on the lower support (1) to solidarize the elements simultaneously.
- The two «clacks» ensure that the three elements are correctly connected.

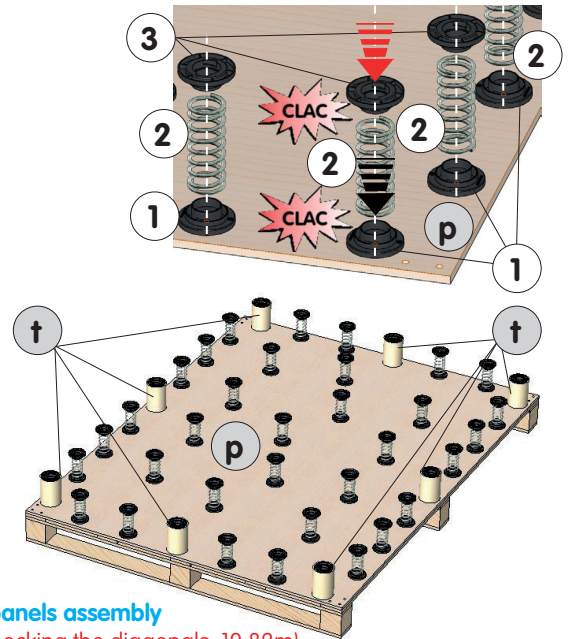
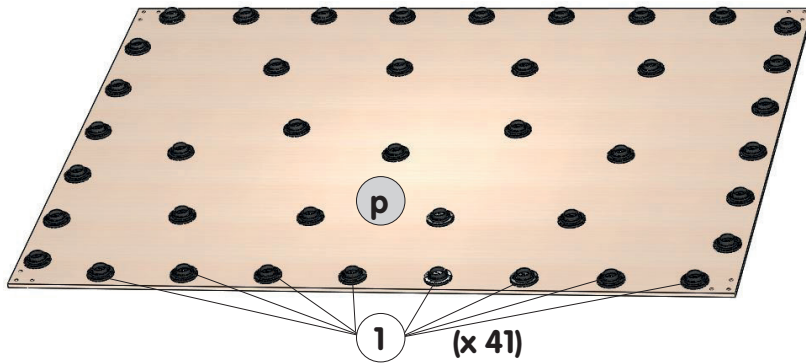

II. Assembling the floor: (2 minimum).



IMPORTANT: CHECK THAT THE PACKAGING TUBES (†) OF THE PANELS (REF.: 6785A) ARE COMPLETELY REMOVED DURING ASSEMBLY.

STORE THEM FOR FUTURE STORAGE AND/OR TRANSPORT.

Figure 3 - Arrangement and order of the panels assembly

- On the ground, mark the overall dimensions of the floor: a 14 x 14 m square (Checking the diagonals: 19.82m)
- Assemble the 63 panels (4), (5) & (6) and the edges (7): start with 1 right corner panel (4), then follow the specified order (Blue N°)

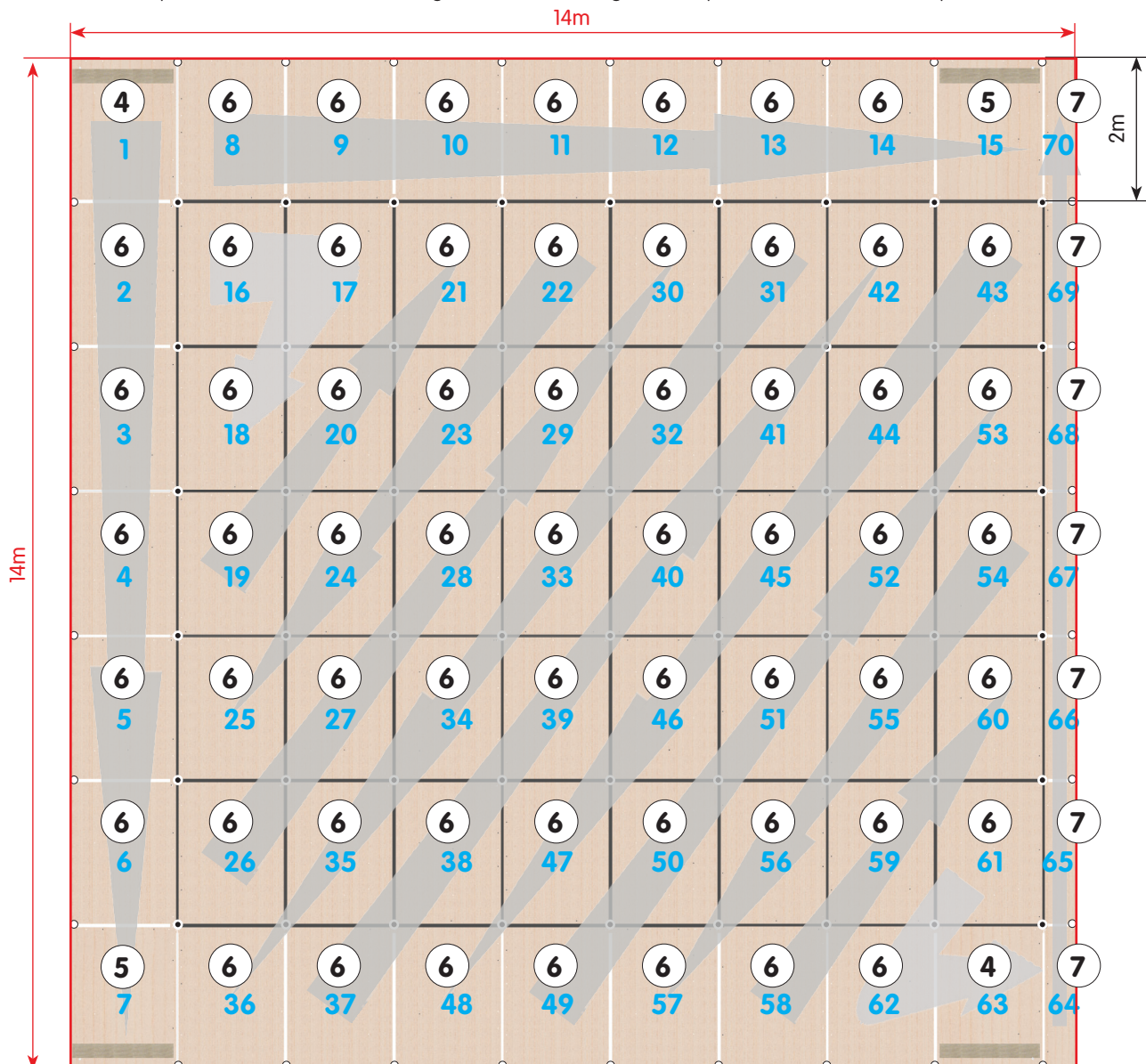

Figures 4, 5, 6, 7 & details - Orientation of the 4 corner panels



ATTENTION, THESE 4 PANELS (4) AND (5) ARE EQUIPPED WITH:

- Hook-and-loop strips (**m**) of the foam ARK, to be placed on the periphery of the floor
- And guying plates (**h**), provided for the hooking of the cables (**c**) of the floor ARK, to be orientated towards the interior of the floor.

Right corner panel - Top & Bottom Views

Left corner panel - Bottom & Top Views

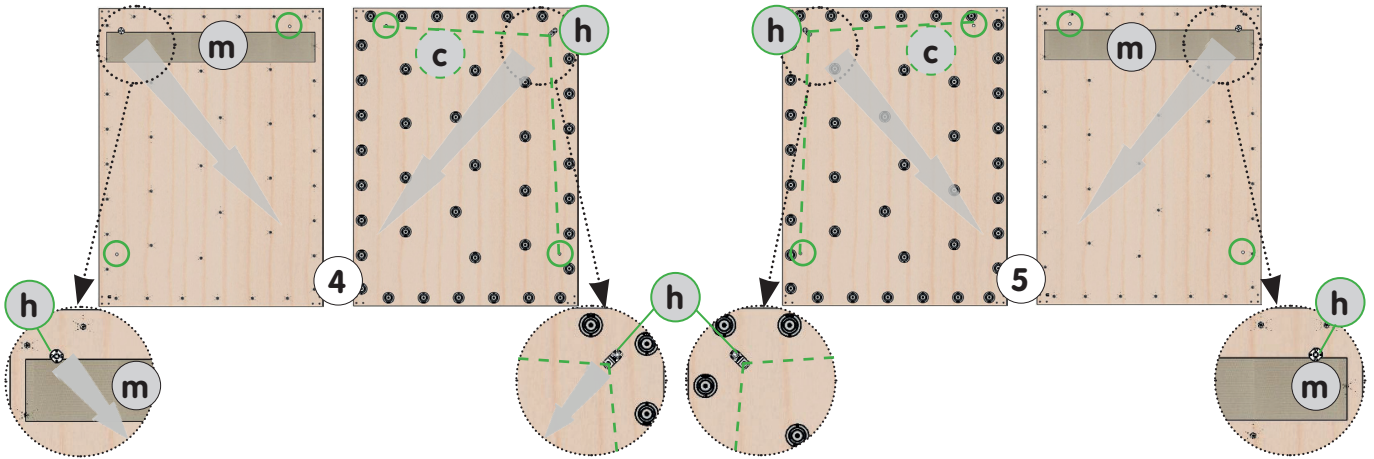

Figure 8 - Distribution of floor panels and connecting parts

- Assemble the white profiles (**10**), (**11**) & (**12**) and the white locking plates (**14**) on the periphery of the floor (Connection 2 panels).
- Assemble the grey profiles (**8**) & (**9**) and the white & grey locking plates (**13**) on the central part (Connection between 4 panels).

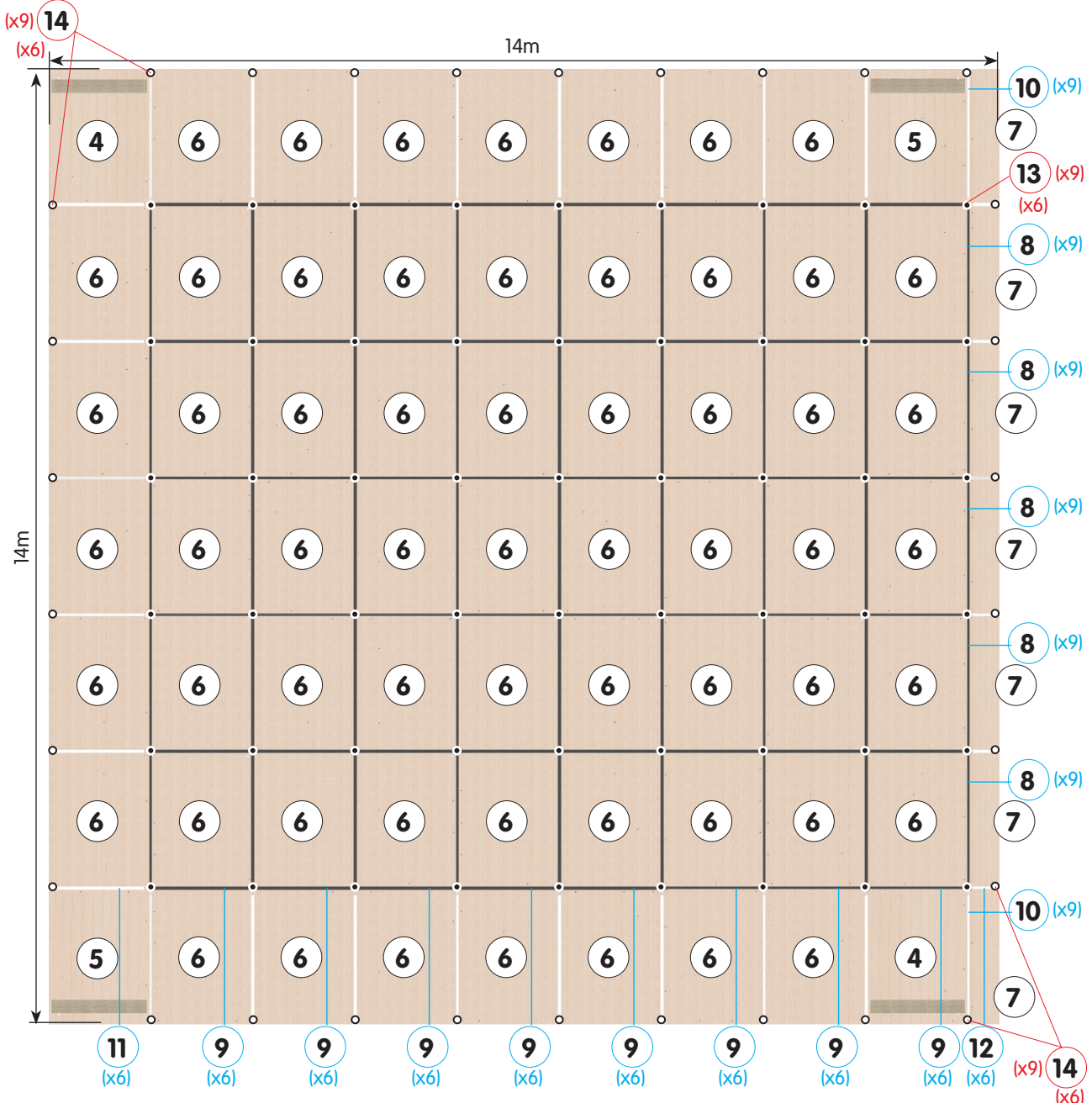

Figure 9 & details - Installation of the connecting parts

- Mount the locking plates (13) & (14) and the profiles (8), (9), (10), (11) & (12) as the panels are assembled.
- Center the profiles on each side of the floor panels (4), (5) & (6).
- Lock the plates (13) & (14) ✓.

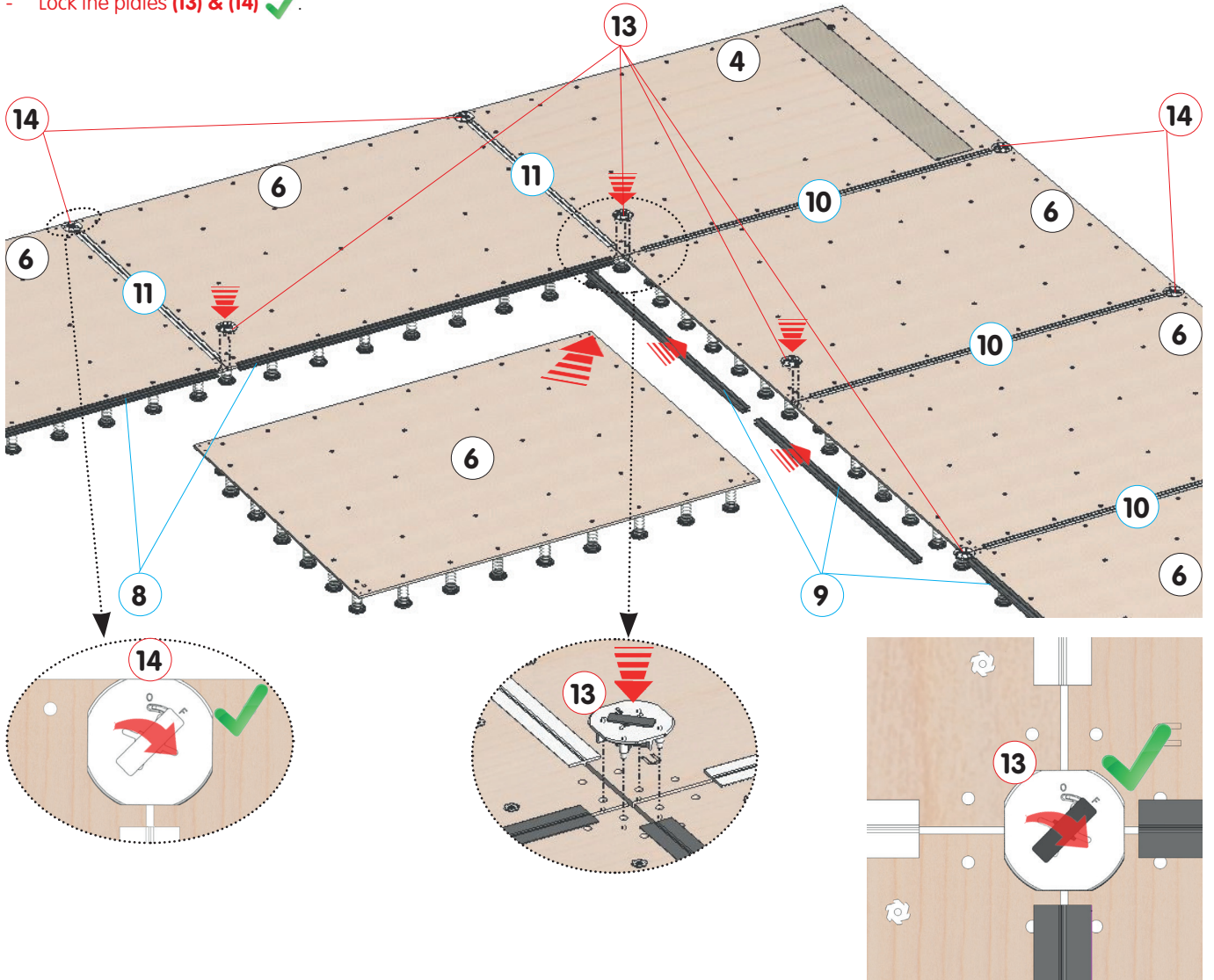
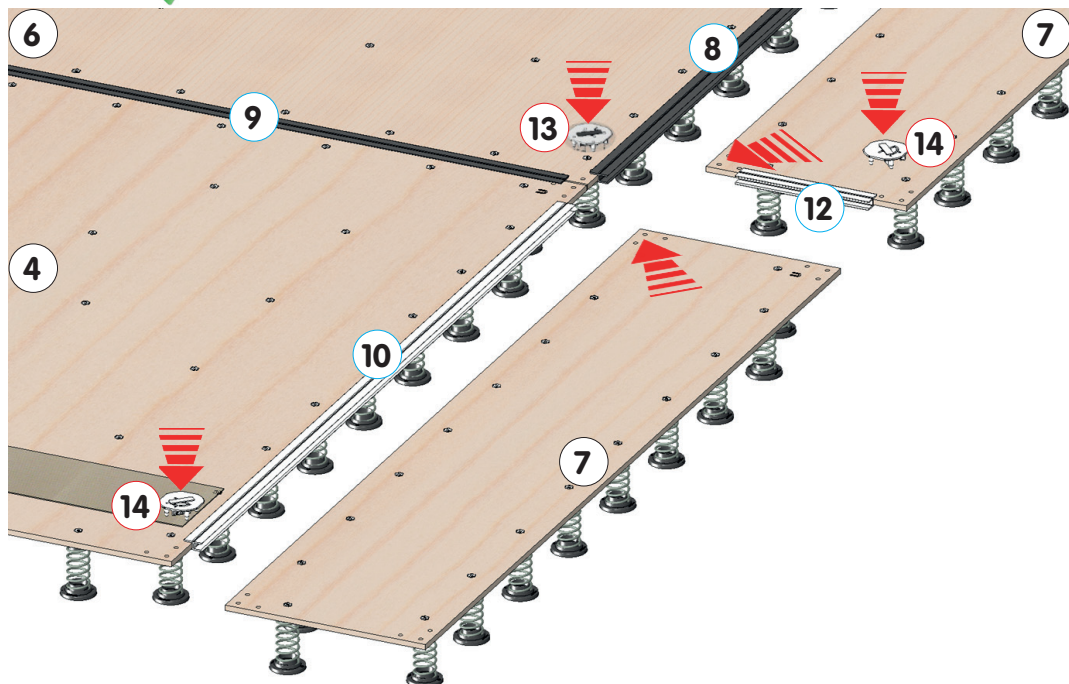

Figure 10 - Installation of the edge panels

- Install the 4 cables of the Floor Anti-Rotation Kit (15) according to instructions NM277.
- Finish by assembling the 7 floor edge panels (7).
- Lock the plates (13) & (14) ✓.



III. Assembling the impact-absorbing foam area:

- Exercise floor Refs.: 6775D - 6775D/DE -> Foam area 14 x 14m - th.: 56mm (Ref.: 6788B) : refer to instructions NM299.
- Exercise floor Refs.: 6776C - 6776C/DE -> Foam underlay 14x14m th. : 24mm (Ref.: 6776/10) : refer to instructions NM285.

IV. Assembling the overlay carpet or roll-up tracks evolution area:

- Exercise floor Refs.: 6775D - 6775D/DE -> Carpet 14 x 14m (Ref.: 6380H) : refer to instructions NM254.
- Exercise floor Refs.: 6776C - 6776C/DE -> Roll-up tracks evolution area 14x14mth : 3.8cm (Ref.: 6776/00) : refer to instructions NM286.

V. Disassembling and storing the floor: (2 minimum).

Figure 11 & details - Disassembling the floor

- Unlock the plates (13) & (14) ✓
- Dislodge the locking plates (13) & (14) and remove the profiles (8), (9), (10), (11) & (12).
- Dismantle the floor panels (4), (5), (6) & (7) as you go.

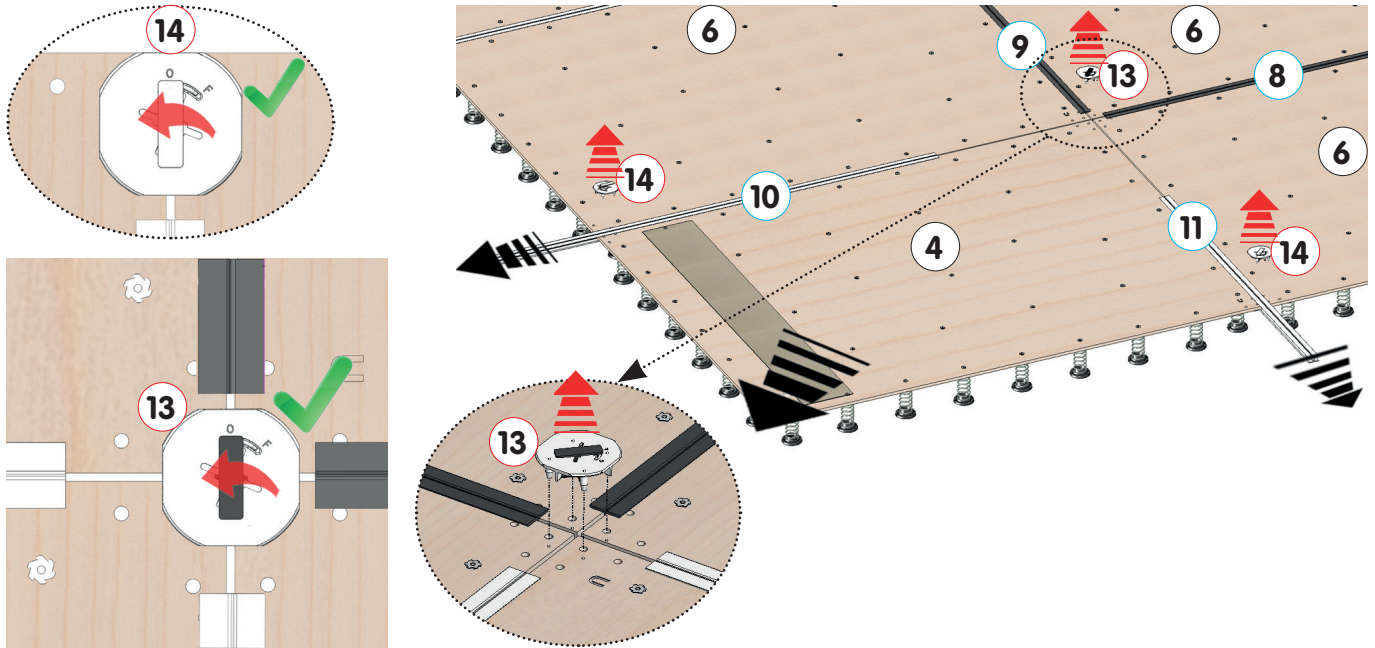

Figures 12, 13, 14 & 15 - Frequent storage for short periods

- Store floor panels (4), (5), (6) & (7) well vertically, nested 2 to 2 in each other.

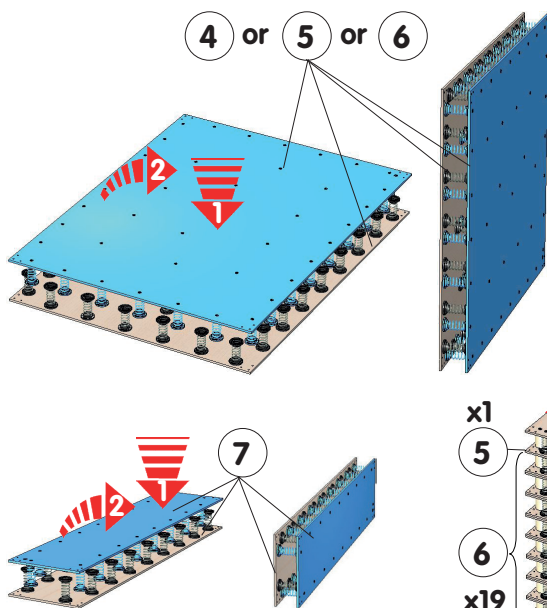

Figures 16, 17 & 18 - Prolonged storage

- It is imperative to stack the floor panels (4), (5), (6) & (7) horizontally, nested 2 to 2 in each other.
- Use the original cardboard tubes (t) between the panels: 8 for the plates 2 x 1.50m, and 4 for the edges.

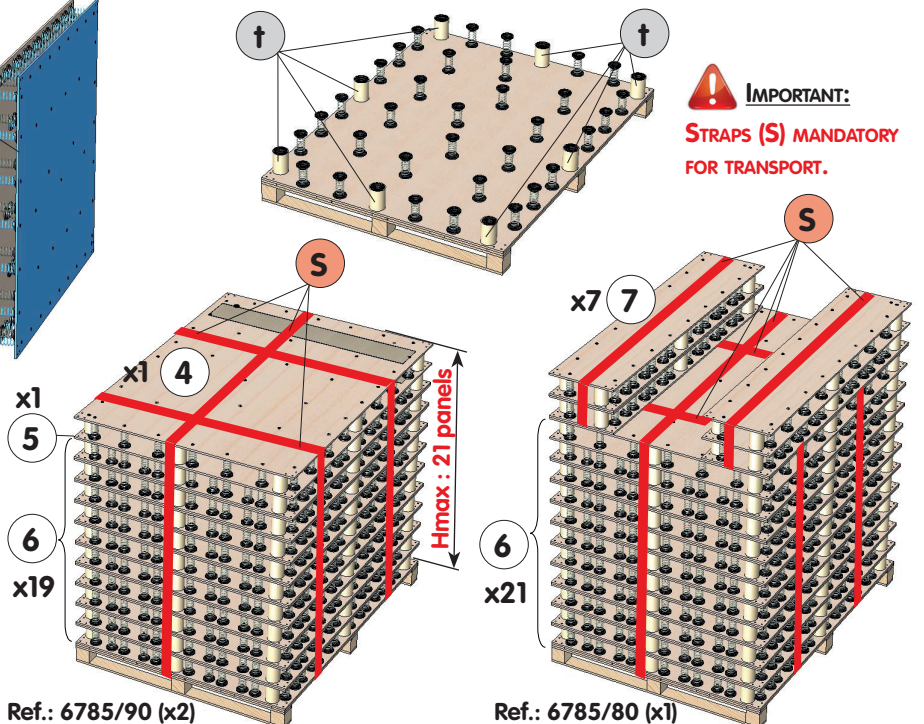

IMPORTANT:
STRAPS (S) MANDATORY
FOR TRANSPORT.

Ref.: 6785/90 (x2)

Ref.: 6785/80 (x1)

«MS» : Mounted Springs - «NMS» : Not Mounted Springs

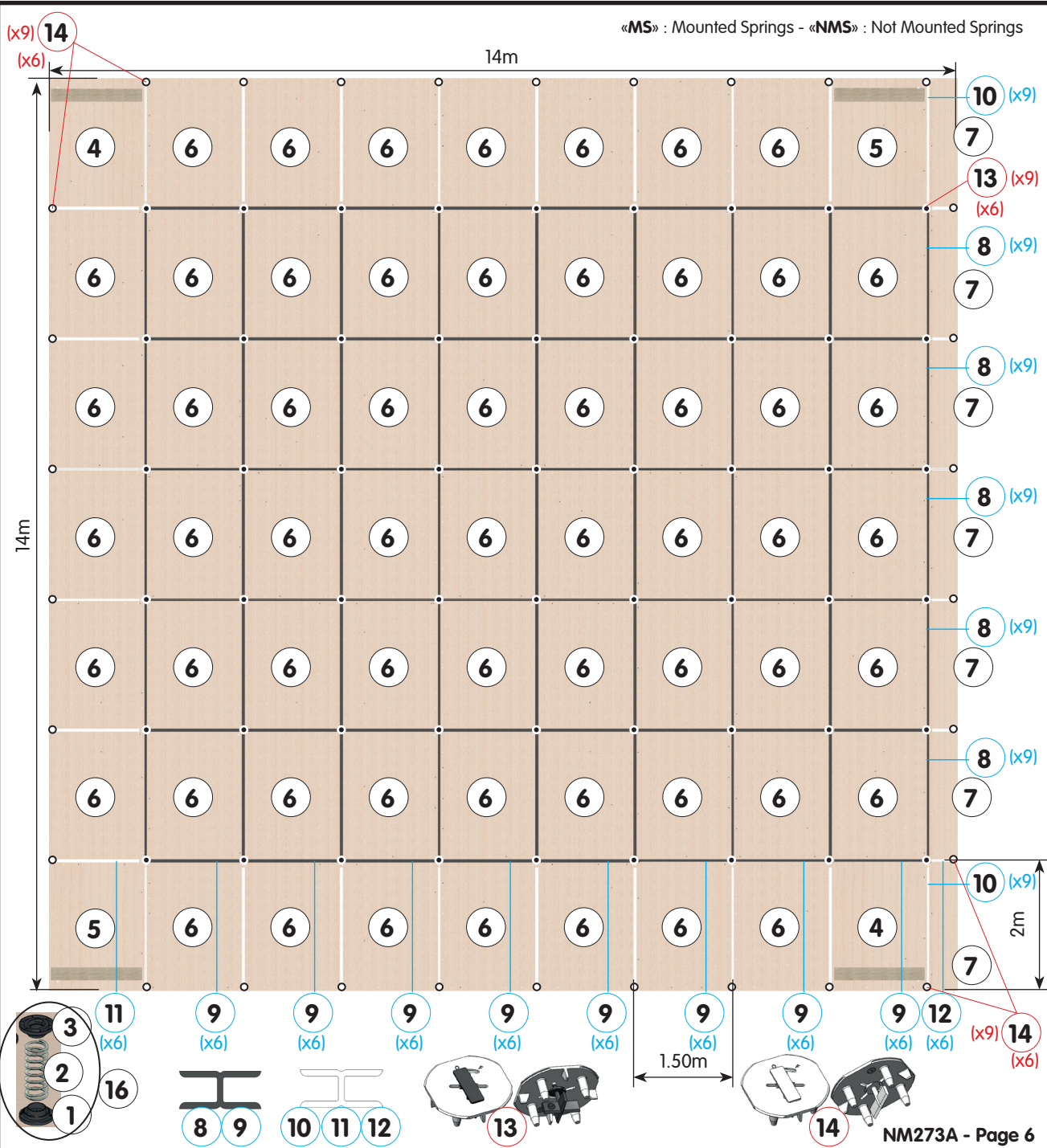

26	-	-	-	-
25	-	-	-	-
24	-	-	-	-
23	-	-	-	-
22	-	-	-	-
21	-	-	-	-
20	-	-	-	-
19	-	-	-	-
18	-	-	-	-
17	-	Set of 280 cardboard tubes / storage	6785/50	H. 13cm
16	1	Set of 5 mounted springs + fixings	6785/100	H. 13cm
15	1	Floor Anti-Rotation Kit - 4 cables	6529D	Complete - NM277
14	30	2 ribs locking plate + Lock White	6785/73	Unit - periphery
13	54	4 ribs locking plate + Lock Grey	6785/63	Unit - central part
12	6	White connecting profile Length 30cm	659/09	Unit - periphery
11	6	White connecting profile Length 1.30m	659/06	Unit - periphery
10	18	White connecting profile Length 1.80m	659/05	Unit - periphery
9	48	Grey connecting profile Length 1.40m	6785/05	Unit - central part
8	45	Grey connecting profile Length 1.90m	6785/06	Unit - central part
7'	7	2 x 0.45m Edge panel NMS	6787/44	6775D/DE - 6776D/DE
7	7	2 x 0.45m Edge panel MS	6785/84	6775D - 6776D
6'	59	2 x 1.50m Central panel NMS	6787/41	6775D/DE - 6776D/DE
6	59	2 x 1.50m Central panel MS	6785/81	6775D - 6776D
5'	2	2 x 1.50m Left corner panel NMS	6787/42	6775D/DE - 6776D/DE
5	2	2 x 1.50m Left corner panel MS	6785/82	6775D - 6776D
4'	2	2 x 1.50m Right corner panel NMS	6787/43	6775D/DE - 6776D/DE
4	2	2 x 1.50m Right corner panel MS	6785/83	6775D - 6776D
3	2709	Spring upper support	-	6775D/DE - 6776D/DE
2	2709	Black spring only diam. 4 - H. 12.5cm	-	6775D/DE - 6776D/DE
1	2709	Spring lower support	-	6775D/DE - 6776D/DE
ITEM	QTY	DESCRIPTION	REFERENCE	REMARKS

14 x 14M THICKNESS 14CM SPRUNG FLOORS WITH MOUNTED & NOT MOUNTED SPRINGS «MONTREAL» EVOLUTION COMPETITION EXERCISE FLOOR M'20

To order spare parts, please provide the description, reference and delivery date of the entire apparatus.

Constantly aiming to improve our products, we reserve the right to make changes to the equipment and dimensions without further discussion.

This document is the propriety of Gymnova, it is confidential and shall not be reproduced.

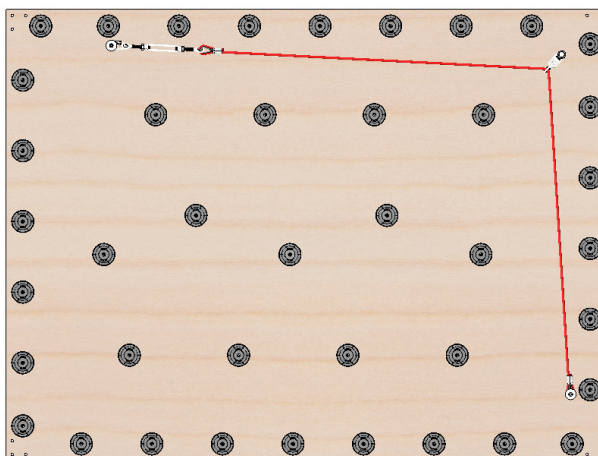
**STOPPER CABLES AND ANTI-ROTATION KITS FOR
14 x 14 M & 13 x 13 M FLOORS OF SPRUNG
EXERCISE FLOORS M'16.****6529/00
6529D***KEEP THIS
DOCUMENT***Warning:**

This equipment should be installed by a qualified individual. The attachments that are provided with these kits may only be used if the support complies with specification **CC78**. Using this equipment for purposes other than those originally intended is prohibited.

Recommendations:

As set out in French Standard NF S52-400 the following is recommended:

- keep these instructions for subsequent reference (inspection, maintenance, etc.).
- periodically carry out predictive maintenance.
- depending on how often it is used, have the equipment serviced yearly or every few years.

Pack list:

1 Pack (Ref: **6529/00**) -> Set of 4 adjustable stopper cables + floor attachments:

Weight: 4.5 kg Dimensions: 310 x 210 x 200 mm Volume: 0.01 m³

1 Pack (Ref: **6529D**) -> Set of 4 complete adjustable stopper cables:

Weight: 5.5 kg Dimensions: 300 x 210 x 200 mm Volume: 0.01 m³

Uses of stopper cables:

These cables stop the rotation and/or translational motion of the high elasticity floors in GYMNOVA gymnastics sprung exercise floors (Ref: 6775 & 6775/DE - 6777 & 6777/DE).

I. Assembly of Anti-Rotation Kit: minimum

1 Locate the 2 holes on each corner panel - Left **(1)** and Right **(2)** (symmetrical floor): position of drilled holes for Anti-Rotation Kit attachments.

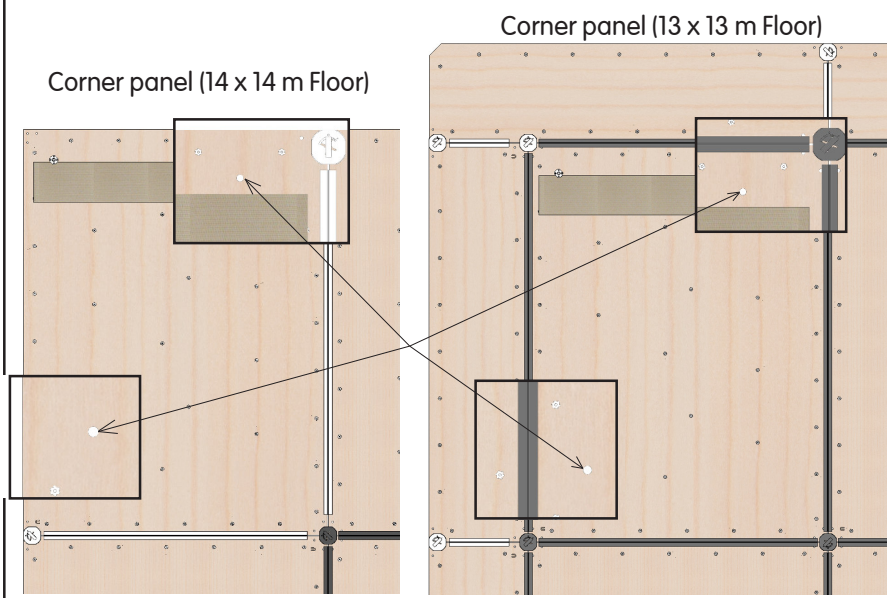

2 Pre-drill the flooring (Ø12mm) through the holes of the panels

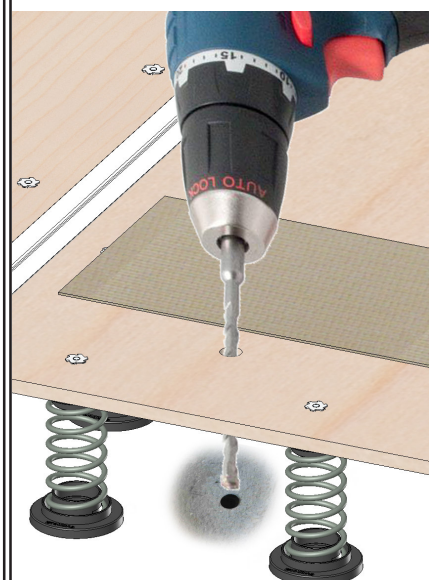

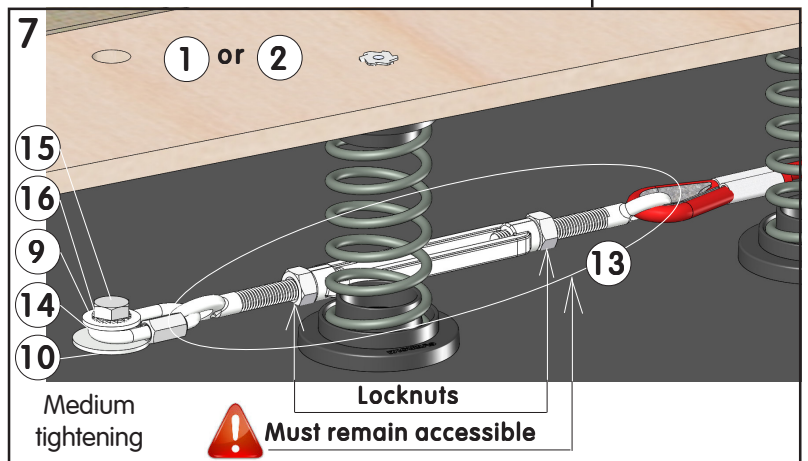
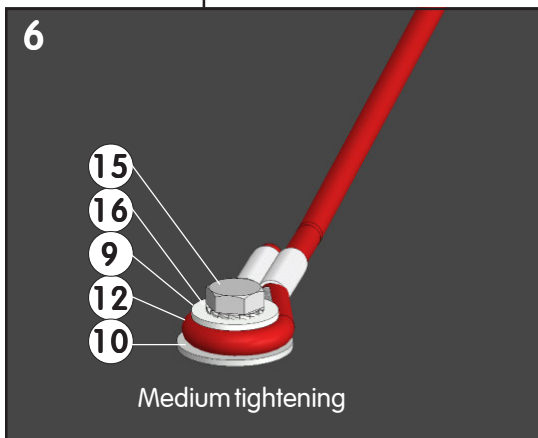
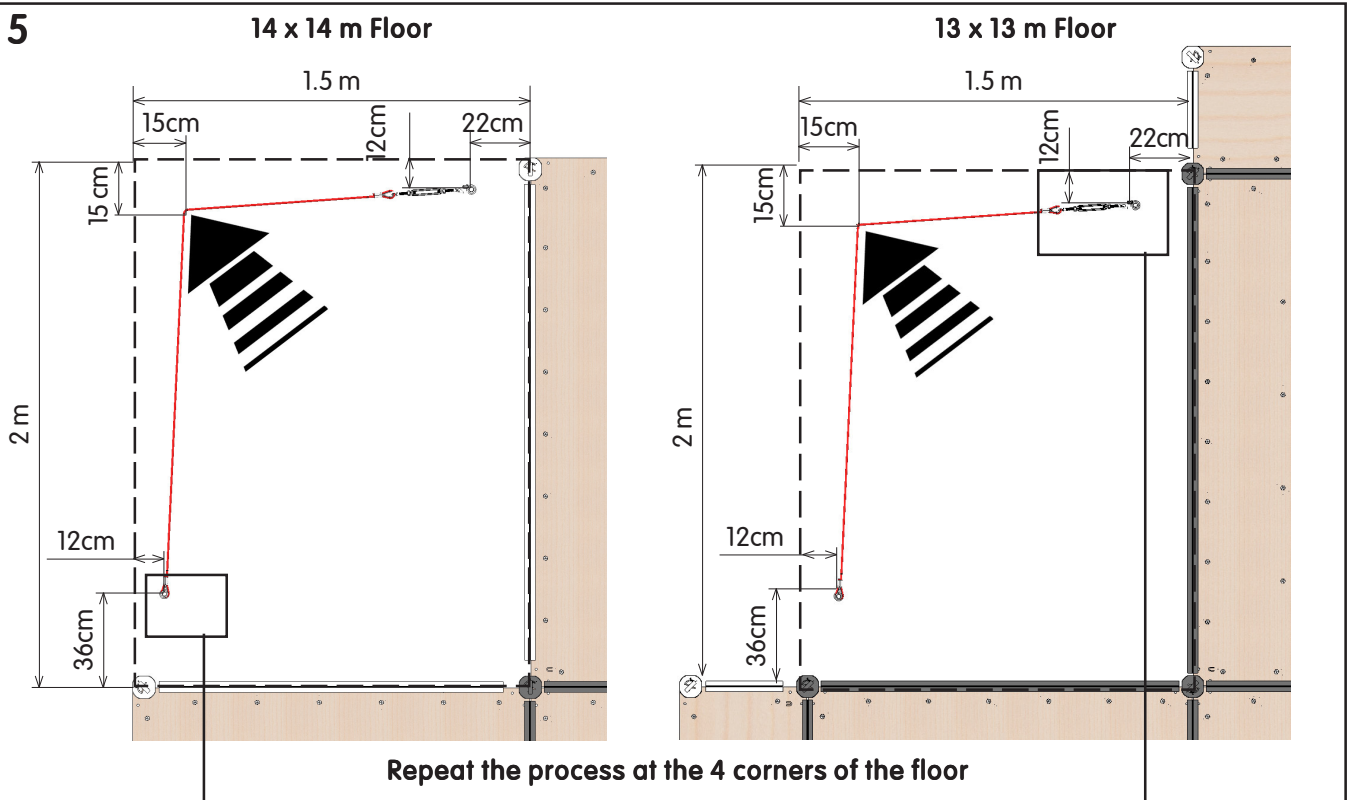
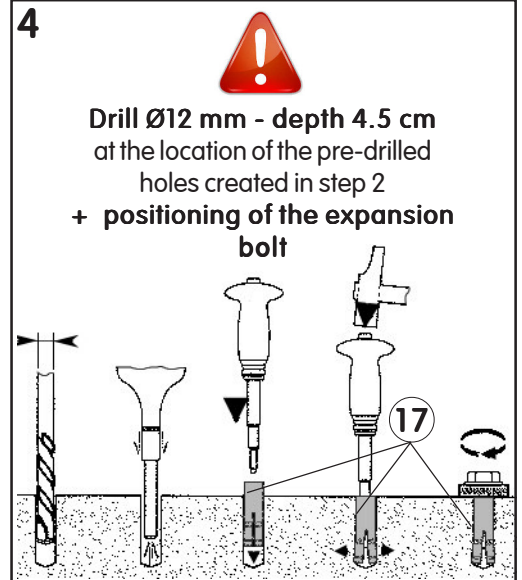
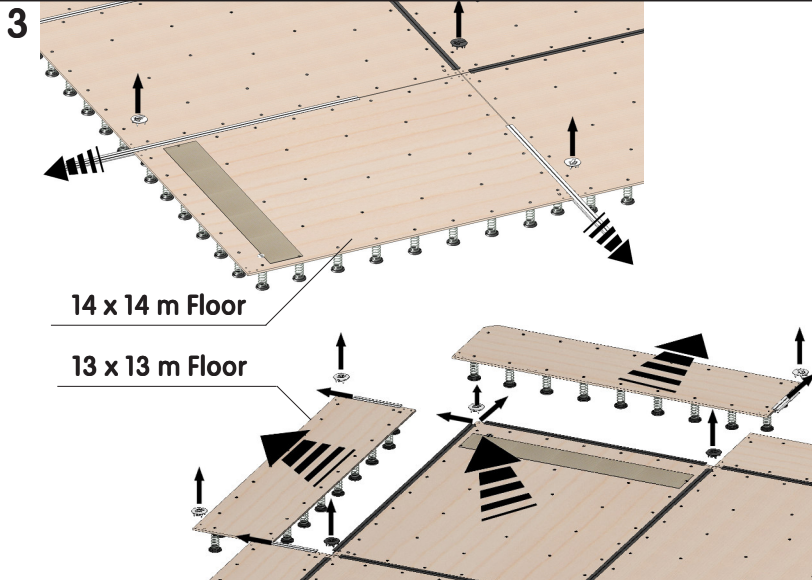

8

14 x 14 m Floor

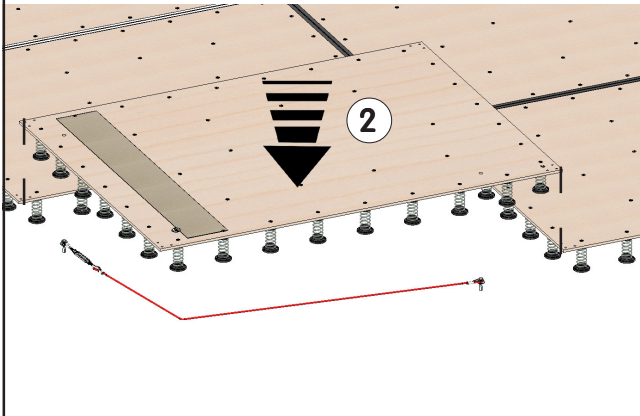

13 x 13 m Floor

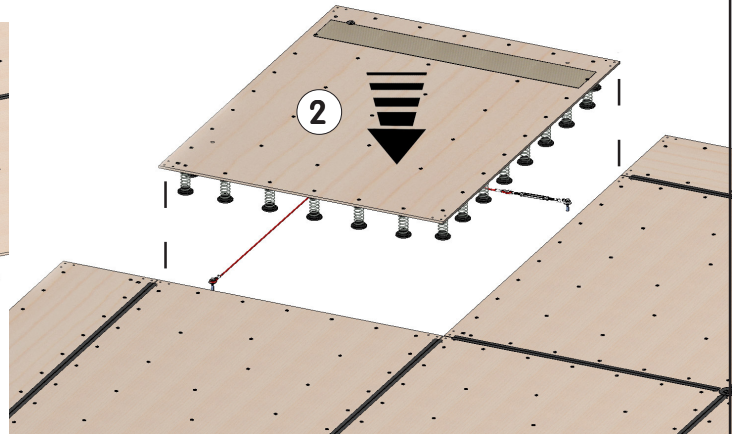

9

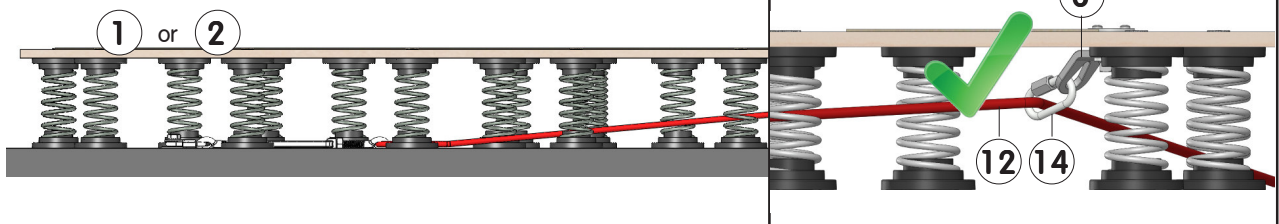

10

14 x 14 m Floor

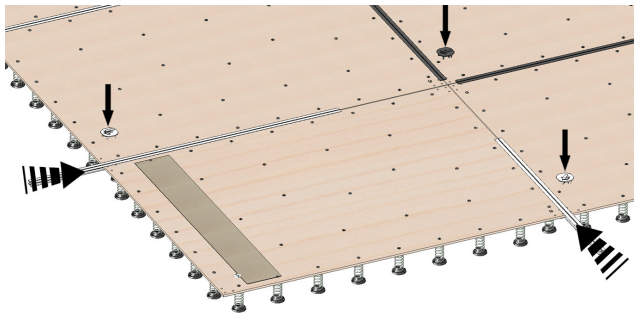

13 x 13 m Floor

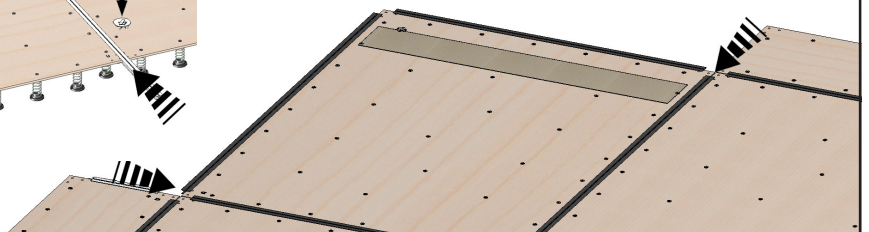

11

Screw in each tensioner (13) so that the cable (12) no longer rests on the floor. Firmly tighten the floor attachments (10, 9, 16 & 15). Hold the tensioner with a screwdriver and lock the locknuts with the spanner.

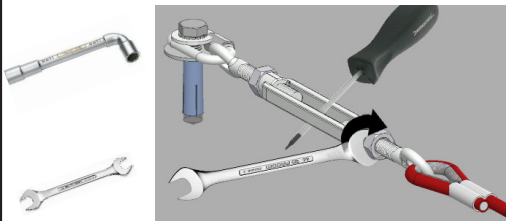

Tube spanner and open end spanner no. 16 or 17.

12

13 x 13 m Floor only

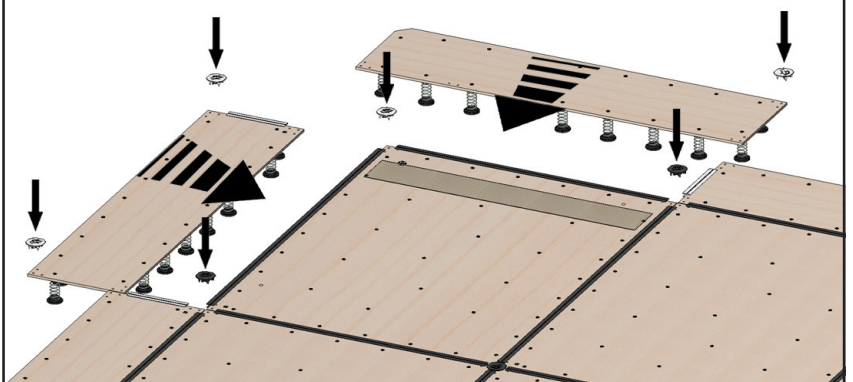

Maintenance:

- Regular cleaning of the floor will make it easier to spot any problems (distortion, breakage or corrosion).
- Before each use, make a thorough check on the condition of the components: wear of bracing flats (6), cables (12), quick links (14) and turnbuckles (13).
- Periodically check the tensioning of cables (11), locking of tensioners (13), and closure of quick links (14).
- Check that the attachments (15) are locked and that the bolts (17) are not coming away from the flooring.

Important:

- If a problem is found or suspected, do not use the equipment until it has been checked by a technician.
- Any damaged or distorted component should be replaced as quickly as possible.

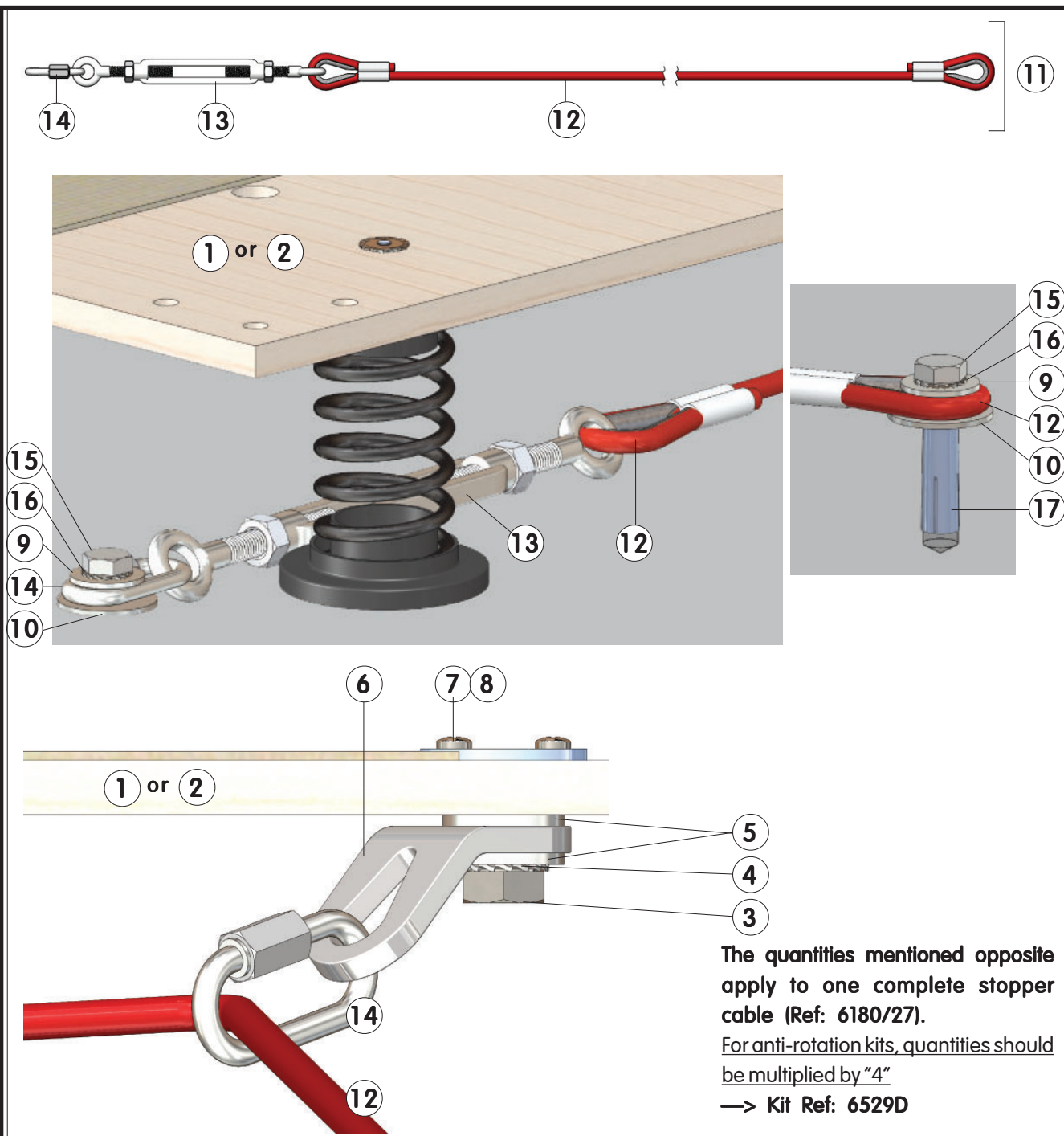

The quantities mentioned opposite apply to one complete stopper cable (Ref: 6180/27).
 For anti-rotation kits, quantities should be multiplied by "4"
 → Kit Ref: 6529D

To order spare parts, please provide the description, reference and delivery date of the entire apparatus.

30	-	-	-	-
29	-	-	-	-
28	-	-	-	-
27	-	-	-	-
26	-	-	-	-
25	-	-	-	-
24	-	-	-	-
23	-	-	-	-
22	-	-	-	-
21	-	-	-	-
20	-	-	-	-
19	-	-	-	-
18	-	-	-	-
17	2	M10 hammer-type exp. bolt	QCEC100000	Floor attachments
16	2	External tooth lock washer dia. 10 x 18	VREE10180Z	Floor attachments
15	2	H M10 x 30 ZP screw	VH0010030Z	Floor attachments
14	2	Quick link No. 6	QMRA00006Z	1 included in 11
13	1	M10 O/O turnbuckle	QTELE1010G	included in 11
12	1	5.5 dia. cable - length: 2.26 m	-	included in 11
11	1	Adjustable stopper cable	-	each
10	2	LL 10 x 36 flat washer	VRP010360Z	Floor attachments
9	2	L 10 x 27 flat washer	VRP010270Z	Floor attachments
8	2	Pan-head chipboard screw, dia. 4 x 16	VVBZ40016Z	included in 1 and 2
7	1	M12 screw nut	VEAV12210Z	included in 1 and 2
6	1	Bracing flat	X3120/12	included in 1 and 2
5	2	LL 14 x 36 flat washer	VRP014360Z	included in 1 and 2
4	1	External tooth lock washer dia. 12 x 20	VREE12200Z	included in 1 and 2
3	1	H M12 x 25 ZP screw	VH0012025Z	included in 1 and 2
2	-	Right corner panel 2 x 1.5 m	6785/13	-
1	-	Left corner panel 2 x 1.5 m	6785/12	-
ITEM	QTY	DESCRIPTION	REFERENCE	REMARKS
		GYMNOVA	STOPPER CABLES AND ANTI-ROTATION KITS 14 x 14 M & 13 x 13 M FLOORS FOR SPRUNG EXERCISE FLOORS M'16	
		RUE GASTON DE FLOTTE 13012 MARSEILLE Tél. : 33-(0)-4-91-87-51-20 Fax : 33-(0)-4-91-93-86-89		
		BY : M. CHARBONNEAU	DATE : 07/03/17	NM277-GB
				Ref. : 6529/00 - 6529D
THIS DOCUMENT IS THE PROPERTY OF GYMNOVA. IT IS CONFIDENTIAL AND SHALL NOT BE REPRODUCED WITHOUT PRIOR AUTHORIZATION				